

# SIRUBA

操作手冊

OPERATION MANUAL

■ BH9820

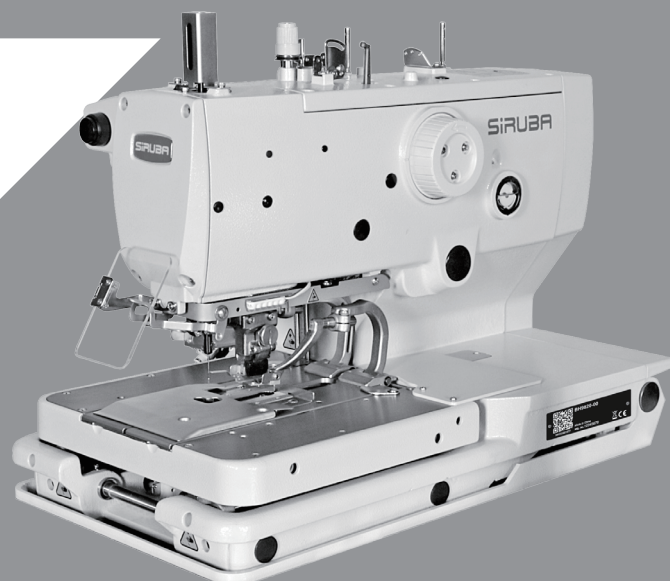

CE



**ENGLISH**

**ENGLISH**





## GENERAL SAFETY INSTRUCTION







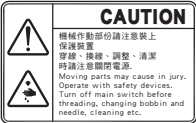



For the sewing machine, automatic mechanic system, and auxiliary devices (hereinafter referred as “machine” ), it is inevitable to conduct work near moving parts of the machine. This means that there is always a potential risk from the moving parts. Operators actually operating the machine and service technicians performing maintenance and repair are strongly advised to read and understand fully the following instructions in advance.

The safety instructions include items which are not listed in the specifications of your product.

**It is the manager/supervisor’s responsibility to have their fellow workers fully understand before operation. Fail to follow the instructions listed in this manual may cause severe injury or even death, and damage to the property.**

Explanation of warning indications and labels.

 <p>高壓電危險 DANGER 注意: 修理前請關閉電源 TO OPEN THE COVER TURN OFF POWER SUPPLYING AND WAIT MORE THAN 10 MINUTES BEFORE WORKING.</p>	<p>CAUTION HIGH VOLTAGE</p> <p>Do not open the cover of control box within 10 minutes after turn off the power.</p>	 <p>Be careful of its movement. 移動快速 敬請小心</p>	<p>HIGH SPEED MOTION POSITION</p> <p>In case of industrial accident</p>
 <p>CAUTION 機械作動部份請注意 保護裝置 穿線、換線、調整、清潔 時請注意斷電。 Moving parts may cause injury. Operate with safety devices. Turn off main switch before threading, changing bobbin and needle, cleaning etc.</p>	<p>CAUTION HIGH SPEED MOVING PARTS</p> <p>PREVENT FROM WORK-RELATED INJURIES</p>		<p>HIGH SPEED MOTION POSITION</p> <p>In case of industrial accident</p>

PICTORIAL WARNING INDICATION		PICTORIAL WARNING INDICATION	
	<p>There is a risk of injury if contacting a moving section.</p>		<p>Be aware that holding the sewing machine during operation can hurt your hands.</p>
	<p>There is a risk of electrical shock if contacting a high-voltage section.</p>		<p>There is a risk of entanglement in the belt resulting in injury.</p>
	<p>There is a risk of a burn if contacting a high-temperature section.</p>		<p>There is a risk of injury if you touch the button carrier.</p>
	<p>Be aware that eye de ciency can be caused by looking directly at the laser beam.</p>	INDICATION LABEL	
	<p>There is a risk of contact between your head and the sewing machine.</p>		<p>The correct direction is indicated.</p>
			<p>Connection of a earth cable is indicated.</p>

## SAFETY PRECAUTIONS

### Danger

An accident means ” to cause personal injury or death, or damage to property.”

When it is necessary to perform service on electrical parts, be sure to turn the power off and wait for 5 minutes or more before opening the power cabinet/box in order to avoid electrical shock.

### Caution

#### 1. Basic precaution

- (1) Read the manual and other papers supplied with accessories of the machine before operation. Keep the manual and papers at hand for quick reference.
- (2) The content of this section includes items which are not listed in the specification of your product.
- (3) Always wear safety goggles and gloves to avoid accident caused by parts breakage.
- (4) For those who use a heart pacemaker, please consult the medical specialist first.

#### 2. Safety devices and warning labels

- (1) Check to ensure all safety devices are correctly installed in place and properly before operation.
- (2) If any of the safety devices is removed for service cause, please be sure to replace it back to position and verify that it works normally before resuming operation.
- (3) Always keep the warning labels adhered on the machine clearly visible. If any of the labels is missing or contaminated, replace with a new one at soon.

#### 3. Application and modification

- (1) It is prohibited to use the machine for any application other than its original intention, or in any manner other than that prescribed in the instruction manual.
- (2) Never modify or alter the machine. Any unauthorized change of the specification will not be covered by the warranty.
- (3) Our company assumes no responsibility/liability to damages, injuries, or death resulting from the machine which has been modified or altered.

#### 4. Education and training

- (1) The plant managers/supervisors are obliged to provide education and training to operators and service technicians. A good education/training plan not only avoids personal injury but also prevent damage to the property.
- (2) Only a well-trained operator is allowed to operate the machine.
- (3) Only a certified technician is allowed to perform service to the machine.

#### 5. Situations that you must turn off the power

Turning off the power: press EMG Stop (if there is one), switch off the power, and remove the power plug from the outlet.

- (1) When there is a failure or abnormality, press EMG Stop (if there is one), switch off the power.
- (2) To prevent accident resulting from abrupt start of the machine, before operating the machine, always turn off the power and switch on again.
- (3) When cleaning or inspecting the machine, make sure the machine stops completely after turning off the power.
- (4) When performing service (i.e. changing of adjusting any component), make sure the power is off and the machine stops completely.

6. Remove the power plug by holding the plug section instead of the cord to avoid electrical shock, leakage, or fire accident.
7. Turn off the power whenever the machine is left unattended between works.
8. In case of a power failure or black out, turn off the power to avoid damage or accident.
9. Fail to obey instructions above may cause severe injury or death to the operators.

## PRECAUTIONS TO BE TAKEN IN VARIOUS OPERATION STAGES

### 1. Transportation

- (1) When you lift or move the machine, please take the machine weight into consideration and apply a safe manner. Refer to the specification for the information you need for transportation.
- (2) Apply sufficient safety measures when lifting or moving the machine to avoid falling or dropping.
- (3) To avoid unexpected accident, do not reuse the packing material for transportation.

### 2. Unpacking

- (1) Before proceeding to unpacking, check the balance of the machine and apply necessary tools to hold the proper position.
- (2) When unpacking, follow the instruction printed on the cartoon. Be careful of the nails and chips when unpacking from a wooden rack.

### 3. Installation:

#### 3A. Table and Stand

- (1) Only adopt a qualified genuine table and stand to assure the holding support. In case you need to leave the machine on a surface temporarily for service, make sure the surface is strong enough to hold the weight.
- (2) If casters are applied to the table stand, adopt casters with a locking mechanism only and lock them well to secure the machine during the operation and service.

#### 3B. Cable and Wire

- (1) The cables and wires must comply with the specification and requirement.
- (2) The cables and wires shall be free from bending or extra force. Reserve a free space of at least 30mm between cables/wires and the moving parts.
- (3) Do not apply starburst connection when wiring.
- (4) All connectors must be fixed securely. And always hold the connector body when removing it.

#### 3C. Grounding

- (1) Grounding is necessary and must be done by a certified technician.
- (2) Check and ensure the grounding is secured before operation.

#### 3D. Motor

- (1) The motor must comply with the specification and requirement.
- (2) If there is a belt in the motor transmission, adopt or apply a proper protector to avoid entangling.

### 4. Before Operation

- (1) Before turning on the power, make sure all the connectors, cables, and wires are free from damage, dropout, or looseness.

- (2) Check and make sure the pulley rotation follows the same direction as labels.
- (3) Make sure all the stand casters are locked or fixed in position.
- (4) Keep the working area clean from obstacles.

#### 5. During Operation

- (1) Always keep your fingers, hair, or clothing away from the moving components and moving area. Do not place your personal belongings on the machine.
- (2) The machine is designed to run at high speed. Always keep your hands away from the moving area. Do not resume the work cycle until the machine stops completely.
- (3) Be careful not to be caught by the machine or components when removing or resetting the machine.
- (4) To avoid accident caused by abrupt start, when performing service on the motor or belt, make sure the power is off and the machine stops completely.
- (5) A servo motor is silent as the machine stops. Be sure to turn off the power to avoid an abrupt start.
- (6) Always keep the fan and airway of the power cabinet clean from any obstacle.

#### 6. Lubrication

- (1) Apply only qualified oil and grease onto the parts as instructed in the manual.
- (2) If the lubricant contacts your eye or body, wash it off immediately. Consult a medical care if necessary.
- (3) If the lubricant goes into your body accidentally, go to the nearby medical care immediately.

#### 7. Service

- (1) Only a certified engineer/technician is allowed to perform service to the machine, including adjusting and repairing. Use only genuine parts for replacement. Our company assumes no responsibility/liability for any accident caused by improper repair or adjustment, or the use of any parts other than genuine one.
- (2) Only a certified technician or authorized engineer is allowed to repair or maintenance the electric system.
- (3) When performing service to air-driven parts, like an air cylinder, first disconnect the air supply and expel the air completely to avoid abrupt start.
- (4) Check all screws and nut are fixed well after adjusting and replacement.
- (5) A periodical cleaning is necessary. Make sure the power is off and the machine stops completely before cleaning.
- (6) If the machine functions poorly or abnormally, stop the operation and turn off the power. Contact the authorized dealers or us to request for a technical service support.
- (7) When there is a fuse failure, turn off the power, find out the cause of the failure and apply solution to it, then replace with a new one with the same spec.
- (8) Periodically check and clean the fan airway and the cable/wiring.

#### 8. Working Environment

- (1) The machine should be free from the affection of electro-magnetic wave.
- (2) The power supply should be in good and reliable condition, the fluctuation of rated voltage should be less than 10%.
- (3) Always check the air pressure and quality. Some extra device might be needed if the supply is not reliable.
- (4) The machine is designed to be used with ambient temperature  $5^{\circ}\text{C} \sim 35^{\circ}\text{C}$ , relative humidity 35%~85%.
- (5) To protect the electronic components and for safety cause, when there is a frost resulting from a dramatic temperature rise, disconnect the power and wait until it dry completely.
- (6) For safety cause, when there is a thundering or lightening, stop the operation and disconnect the power supply.
- (7) Do not use TV or radio nearby the machine as to avoid interference.
- (8) Apply necessary protection during operation. Follow applicable regulations set by local administration.
- (9) For disposal of packages, lubricant, and product, please follow the applicable regulations set by local administration.

# Contents

1 GENERAL INFORMATION .....	1
1.1 GENERAL.....	1
1.2 FUNCTIONS & PARAMETERS .....	1
1.3 SHAPE OF STITCH FORM.....	3
1.4 STANDARDIZATION.....	3
1.5 OPERATION METHOD .....	3
2 BASIC OPERATING INSTRUCTION.....	4
2.1 OPERATION PANEL .....	4
2.2 BASIC OPERATION.....	5
2.3 SETTING METHODS OF PATTEN PROGRAM .....	6
2.4 CONFIRM PATTERN UNDER TEST FEED MODE .....	11
2.5 SHIFT OF CUTTER ACTIONS.....	14
2.6 METHOD FOR SHIFTING CLOTH SETTING POSITION .....	14
2.7 THREADING MODE .....	15
3 INSTRUCTIONS ON SEWING OPERATIONS.....	16
3.1 AUTO MODE .....	16
3.2 MANUAL MODE .....	17
3.3 PAUSE SWITCH .....	19
3.4 USAGE INSTRUCTIONS ON CYCLIC SEWING FUNCTION .....	21
4 INTERFACE OF PARAMETER SETTING MODE .....	24
4.1 DESCRIPTION OF FUNCTIONS .....	24
4.2 SOFTWARE VERSION INQUIRY.....	25
4.3 SOFTWARE UPDATE .....	25
4.4 PARAMETER SETTING.....	27
4.5 INITIALIZATION OF PARAMETERS .....	33
4.6 SYSTEM DETECTION .....	34
5 APPENDIX 1 .....	35
5.1 LIST OF WARNING INFORMATION.....	35
5.2 HINT LIST .....	37
5.3 MALFUNCTION SETTLEMENT.....	37
6 APPENDIX 2 .....	39
6.1 INSTALLATION SIZE OF OPERATION PANEL .....	39
6.3 INSTALLATION SIZE OF CONTROL BOX .....	39
6.3 DIAGRAM OF CONNECTION OF THE EXTERNAL CABLE AND CONTROL BOX.....	40
6.4 MASC511EYELET BUTTONHOLE MACHINE SYSTEM DIAGRAM.....	41



# 1 General Information

## 1.1 General

MASC511 Series Computerized Control System for Sewing Machine is characterized by the advanced technology it adopted. Its main shaft motor features large torque, high efficiency, stable running and low noise by adopting the advanced AC Servo Control Technology; its operating panel can meet various demands from clients in attaching; its structure of system is designed in German style which is easy to repair and install; and its system control software can be updated via U disk, providing convenience to client in improving the function of product continuously.





## 1.2 Functions & Parameters

For the functions and parameters of MASC511 Series AC Servo System, please refer to Table 1: Table 1: Comparison of Functions & Parameters

No.	Items	Model MASC511
1	Usage	Men's clothing, Women's dress, Leisure wears, Jeans
2	Sewing Speed	1000—2700rpm
3	Shapes of Stitch Form	Without Bar-tacking Sewing
		Taper bar-tacking Sewing
		Linear bar-tacking Sewing
		Round Bar-tacking Sewing
		Radial Tacking
4	Length of Buttonhole	Eyelet 8-42mm · Linear Buttonhole 5-50mm
5	Stitch Form Pitch	0.5-2.0mm
6	Stitch Form Width	1.5mm-5.0mm, Mechanical adjustment:1.5-4.0mm
7	Length of Taper Bar-tacking	0-20mm
8	Presser Height	Standard 12mm ( Max 16mm )
9	Start Mode	Double-pedal Switch or Hand Switch
10	Cloth-feeding Mode	X/Y/Z 3-Pulse Motor Intermittent Feeding
11	Drive Mode for Trimming Upper/ Bottom	Driven by Solenoid Valve
12	Drive Mode of Cutter	Driven by Solenoid Valve
13	Safety Device	Emergency Stop Switch, Head Turn-over Switch and
14	Method for Pattern Input & Update	U Disk
15	Available Language in Operation	Chinese & English
16	Upper Axis Motor	Small AC Servo Motor 750W, Belt Transmission Drive Mode
17	Air Pressure	Main Adjuster: 0.5MPa; Air-hammer Pressure
18	Power Consumption	600W
19	Operation Temperature Range	0℃ ~45℃
20	Operation Humidity Range	35%~85% ( No Dew Condensation )
21	Line Voltage	AC 220V ± 10% ; 50/60Hz

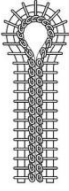
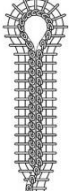
□Effective standard for product:QCYXDK0004—2016 《Computerized Control System for Industrial Sewing Machine》 .

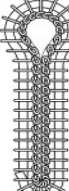
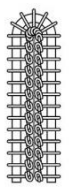
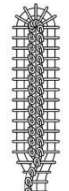
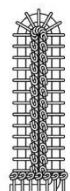
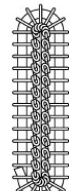
### 1.3 Shape of Stitch Form

Eyelet Buttonhole			
			
No Bar-tacking	Taper Bar-tacking	Linear Bar-tacking	Round Bar-tacking
Linear Buttonhole			
			
No Bar-tacking	Taper Bar-tacking	Linear Bar-tacking	Round Bar-tacking
Radial Hole			
			

### 1.4 Standardization

The function keys adopt the figures known by the public. Since figures are international language, users from any country can recognize them.

### 1.5 Operation Method

By using TFT touching-panel screen, this system features the user-friendly interface and easy operation. For specific method of operation, please refer to the operation instructions.

## 2 Basic Operating Instruction

### 2.1 Operation Panel

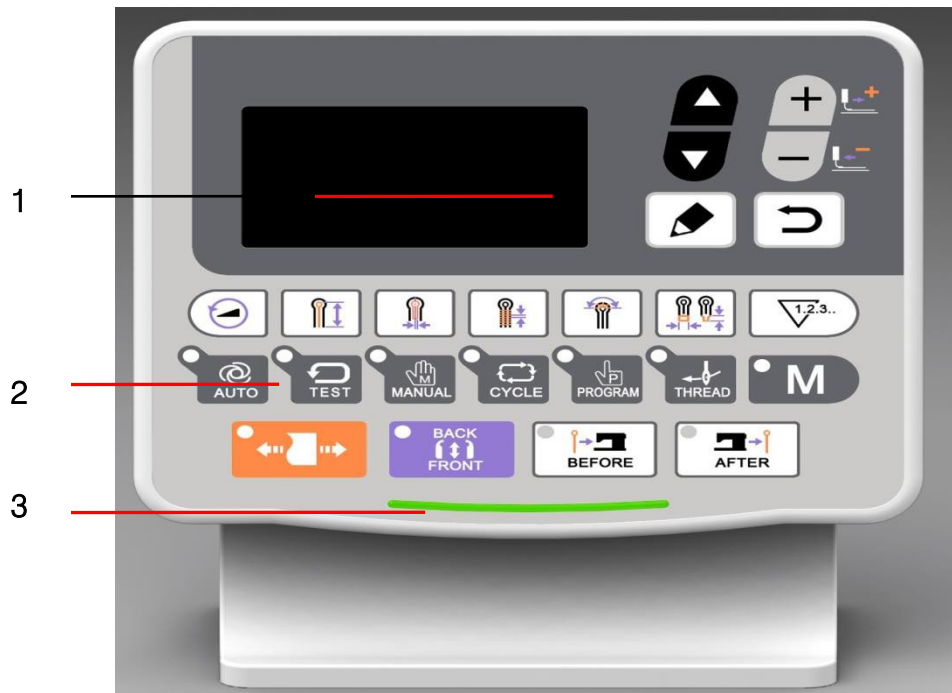

(Front Side)

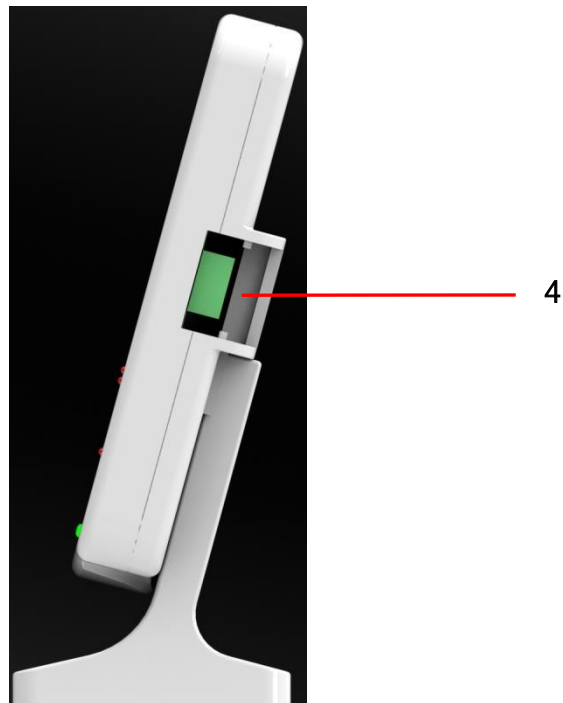

(Right Side)

- 1、Pattern Data Display Area    2、Function Mode Button Area    3、Power Indicator  
4、U Disk Port

## 2.2 Basic Operation

### ① Turn on Power

After user turns on the power, the system will display the contents at below in order at the Pattern Data Display Area:

Welcome to Using MASC511 Series  
Buttonhole

Machine →MASC511-00 (01or 02) →Create Data→  
Please Press Start Switch.

Note: If figure “EB012” is displayed on the operation panel as shown in picture (A) when user turns on the power, please turn the wheel (1) in the directions shown in picture (B) and make the print (2) face to the gap (3) directly.

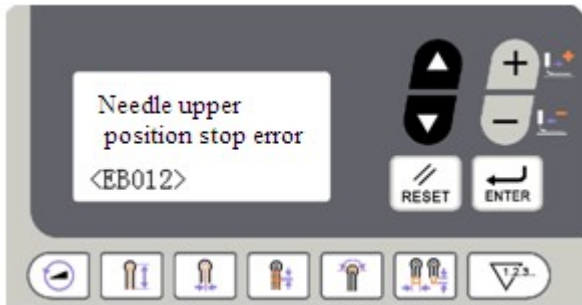
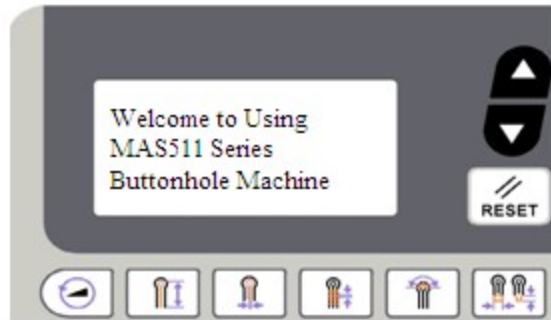

(A)

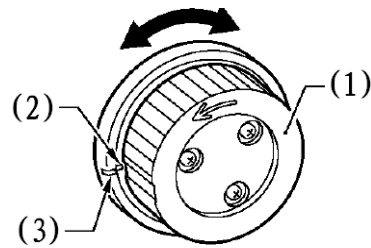

(B)

### ② Press Start Switch

After user steps the right pedal for start, the feeding board will move to the position for laying cloth. In the operation panel, the standby status of the previous operation mode (it might be Auto Mode, Manual Mode, Test Mode, Cycle Mode or Program Mode) will be displayed.

Note: The “Standby Status” is the status before the next action when the system moves to a mode.

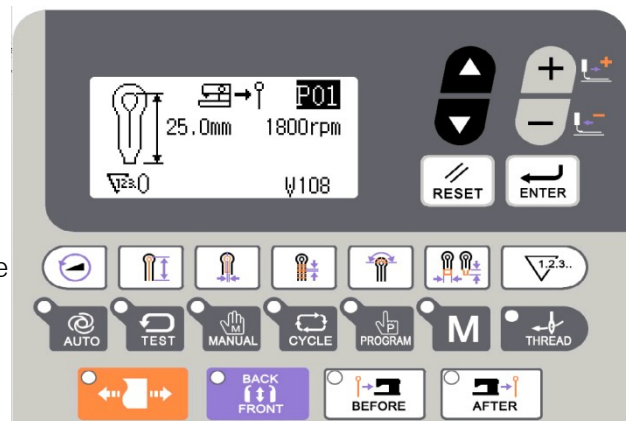

## 2.3 Setting Methods of Patten Program

### 2.3.1 Interface for Inputting Sewing Data

The data input interface is shown in the picture below. For detailed function instructions, please refer to [Table 1: Button Instruction Table].

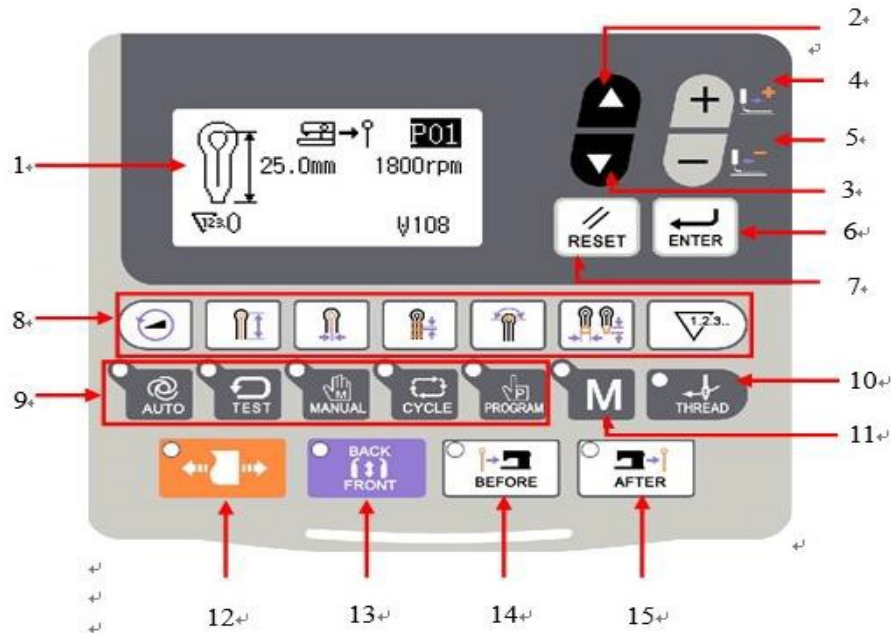

Table 1: Button Instruction Table

No.	Figure	Functions	Remarks
1		Display of Sewing Shape	Display the pattern number, patter shape, length, stitch number,
2		Increase Number of Program	
3		Decrease Number of Program & Parameter	
4		Increase Parameter Content & Value	
5		Decrease Parameter Content	
6		ENTER ( Confirmation ) Key	Confirm the parameter and the pattern data.
7		RESET	Release the display of incorrect information
8		Hot Keys	Quickly change 6 parameters relating to the pattern and the hot key
9		Sewing Mode	Five available sewing modes: Auto,
10		Threading	Enter the threading mode and the indicator light is on.
11		Parameter Management	Enter the parameter setting.

No.	Figure	Functions	Remarks
12		Cloth-tightening Permitted/Forbidden	The indicator light will be on if permitted, and off if forbidden.
13		Front/Back	Shift the cloth-feeding positions from "Front" to "Back". The indicator light will be on if set as "Front", while off if
14		Cut-before-Sewing	Set as cut-before-sewing, the indicator light will be on; while set as cut-after-sewing or no cut, the
15		Cut-after-Sewing	Set as cut-after-sewing, the indicator light will be on; while set as cut-before-sewing or no cut, the indicator light will be off.

### 2.3.2 Setting of Pattern Program

It is advised to preset the parameters of pattern data frequently used so that user would only need to select the pattern number to enter the set pattern in the future usage, which saves the time for resetting the parameters at each time.

20 patterns can be registered at most, and their parameters can be altered at any time.

When leaving the factory, pattern numbers from P01~P20 save the default pattern program (Patterns from P01~P20 are all the same.)

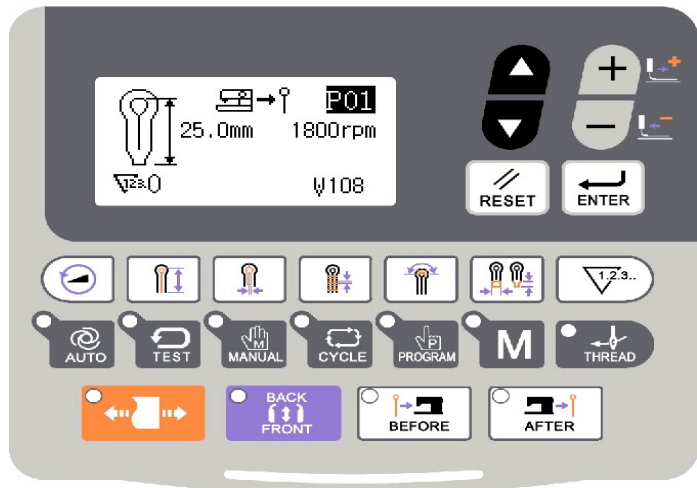

⑧ Press

⑨ Select a pattern number from P01~P20 (1) for changing the content.

Pattern number (1) will change in the following sequence: P01 → P02 → ... P20 → C1→C2...C9, at each

pressing of (press to change the number in the contrary order).



⑩ Press

The pattern data display area will display the parameter number (2) and the specific parameter information (3) of the previous selection.



⑪ Press to select the parameter number (2).



⑫ Press to change

the content of parameter (3).

The flashing parameter information (3) means the content is uncertain.



⑬ Press to confirm the changed content.

If the parameter information stops flashing, that means it has been confirmed. If user presses any key among



instead of ENTER when flashing, the changed parameter (3) will be abandoned and return to the original value.

⑭ Repeat the operation from 4 to

6 to change other parameters.

### 2.3.3 About Hot Keys

Among the Hot Keys, the following 6 parameters are registered for their frequent usage:

(5) Sewing Speed (Parameter No.01)

(6) Length of Lockstitch Sewing at Buttonhole (Parameter No.02)

(7) Cutter Interval (Parameter No.03)

(8) Stitch Pitch (Parameter No.04)

(9) Stitch Number at Eyelet Part (Parameter No.05)

(10) Length of Bar-tacking (Parameter No.06, No.08, No.10)

Note: the different bar-tacking sewing types set in parameter number No.40 are corresponding to the various values of bar-tacking sewing length parameter (10).

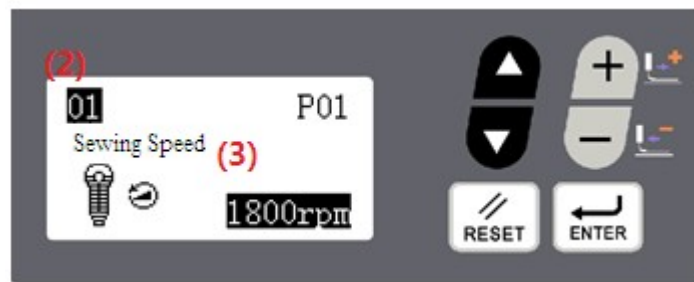



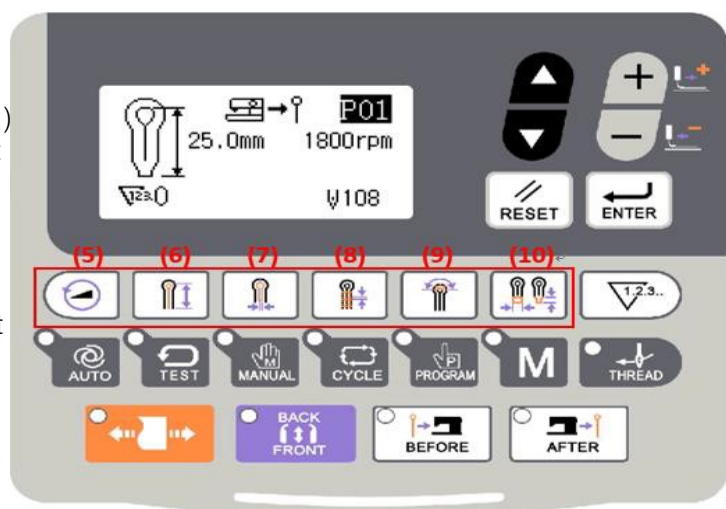











考【花樣























### 2.3.4 List of Pattern Parameters at S level

According to the set content of other parameters, the default value of some parameters may be unchangeable or invalid.

Parameter Number	Content	Range	Unit	Default Value
S01	Sewing Speed 	1000~2700rpm	100	1800rpm
S02	Length of Lockstitch Sewing at Buttonhole 	5~50m m	0.5	25mm
S03	Cutter Interval 	-2.5~0.5mm	0.05	0.2mm
S04	Stitch Pitch 	0.5~2.0mm	0.1	1.0mm
S05	Stitch Number at Eyelet Part 	4~20 Stitches	1	9 Stitches
S06	Length of Taper 	1~20m m	1	6mm
S07	Offset 	0.5~2.0mm	0.1	1.5mm
S08	Length of Linear Bar-tacking 	2.0~6.0m m ( Each side at 3.0mm as	0.1	5.0mm
S09	Stitch Number of Linear Bar-tacking 	5~18 Stitches	1	7 Stitches
S10	Stitch Number of Round Bar-tacking 	5~17 Stitches	1	7 Stitches
S11	Shape of Cutter 	1~6 ( select the proper cutter number, according to the different cutter )	1	2
S12	Sewing Width Adjustment 	-1.0~1.0mm	0.1	0.0mm
S13	Eyelet Part Low Speed 	600~0rpm ( This parameter takes the default value of the parameter 01 sewing	100	0rpm
S14	Speed of Linear Bar-tacking 	1000~2500rpm m ( if the sewing speed is lower than the linear bar-tacking speed, the linear bar-tacking speed will be the same as the	100	1800rpm
S15	Stitch Number of Slow-start 	0~3 Stitches	1	0 stitch

Parameter Number	Content	Range	Unit	Default Value
S16	Speed of Slow-start 	400~1500rpm ( if the sewing speed is lower than the slow-start speed, the slow-start speed	100	700rpm
S17	Cutter Adjustment in X Direction 	-0.5~0.5mm	0.05	0.0mm
S18	Cutter Adjustment in Y Direction 	-0.7~0.7mm	0.05	0.0mm
S19	Stitch number of bar-tacking 	0~4 Stitches	1	0 Stitch
S20	Stitch number of bar-tacking 	0~4 Stitches	1	0 Stitch
S21	Adjustment in X Direction 	-1~6	1	0
S22	Adjustment in Y Direction 	-1~6	1	0
S23	θ1 Adjustment 	-3~3	1	0
S24	θ2 Adjustment 	-3~3	1	0
S25	Taper Bar-tacking Angle 	-5~5	1	0
S26	Bar-tacking Width Adjustment 	-1.0~0.0mm	0.1	0.0mm
S27	Coincidence Amount of Bar-tacking 	0.0mm~2.0mm	0.1	1.0mm
S28	Adjustment of Bar-tacking in X Direction 	-1.0mm~1.0mm	0.1	0.0mm
S29	Adjustment of incline angle of Bar-tacking 	-3~1	1	0
S30	Round Head Correction	-25~25	1	0
S31	Pitch of bar-tacking at sewing-end 	20%~100%	5%	100%
S32	Stitch Number of Round coincidence 	1~4 Stitches (Within 45°)	1	1 Stitch
S33	Stitch moving when without cutting 	1~2	1	1
S34	Cutting Size of Radial Hole 	2~5m	1	2
S35	Stitch Number of Radial	8~100 Stitches	1	20

Parameter Number	Content	Range	Unit	Default Value
	Hole 			
S36	Coincident Stitch Number of Radial Hole 	1~5 Stitches (Within 45°)	1	2
S37	Bar-tacking Pitch	0~30	1	0
S38	Reserved (For future use)			
S39	Pattern Copy	OFF~P01~P20	1	OFF
S40	Type of Bar-tacking 	1: No Bar-tacking 2: Taper Bar-tacking 3: Linear Bar-tacking 4: Round Bar-tacking	1	2
S41	Double tacking availability	OFF/ON		
S42	Eyelet size adjustment	-0.5~0.8	0.1	0
S45	Pattern generation mode	0~1	1	1

## 2.4 Confirm Pattern under Test Feed Mode

In the Test Feed Mode, only cloth-feeding board works normally when the main shaft keeps still. This mode is used to confirm the positional relation between needle and presser.

### ⑨ Press Test Key

Press  to display the stitch form (1), pattern number (2), total stitch number (3) and leftover stitch number (4) in the pattern data display area.

### ⑩ Select the Pattern Number

The pattern number will change in the following sequence: P01 → P02 → ...P20→C1→C2...C9...P01 at each

pressing of  (press  to reverse this sequence).

### ⑪ Step Presser

Pedal

Step the left pedal (5) to lower the presser

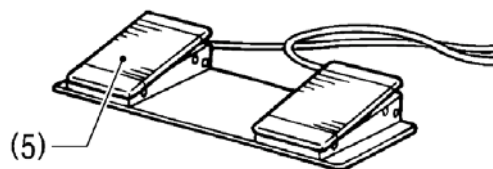

### ⑫ Step the Start Pedal

Step the right pedal (6) to make the cloth-feeding board move to the position of sewing start.

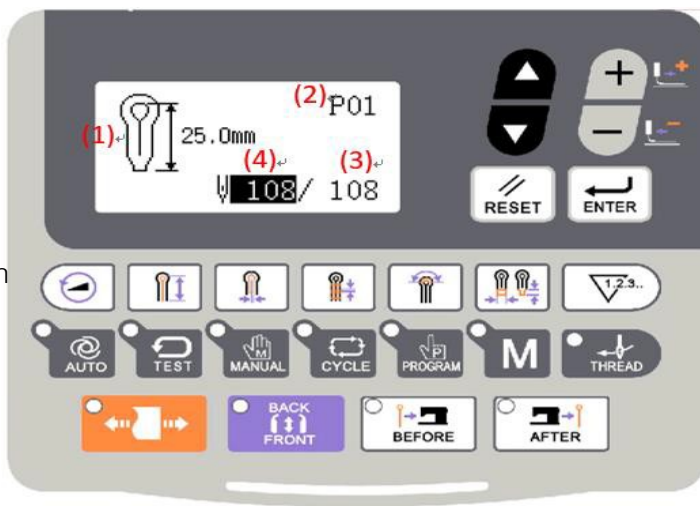
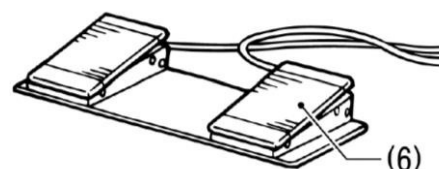

- ⑬ Step Pedal (6) or press  to start the sewing under Test Mode.

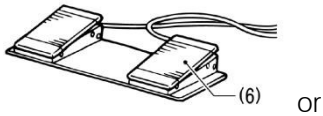

(2 stitches at each pressing.)  
(Holding for continuous sewing)

Note: the leftover stitch number (4) displayed at the data display area will reduce 2 stitches at each time.

The buzzer will work before the last stitch.

No thread-trimming actions and cutter actions in test mode.

- ⑭ If user wishes, the cloth-feeding board to return to the cloth setting position at the end of the test

Please press Pause Switch (7), and

then press  key.

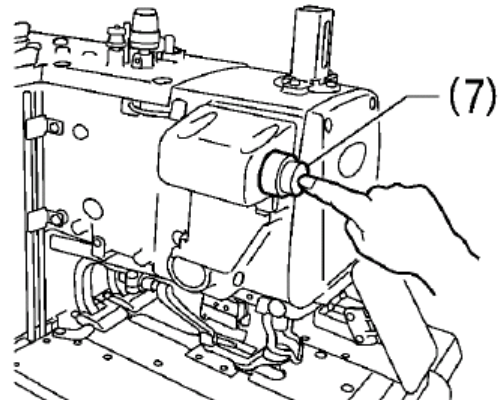
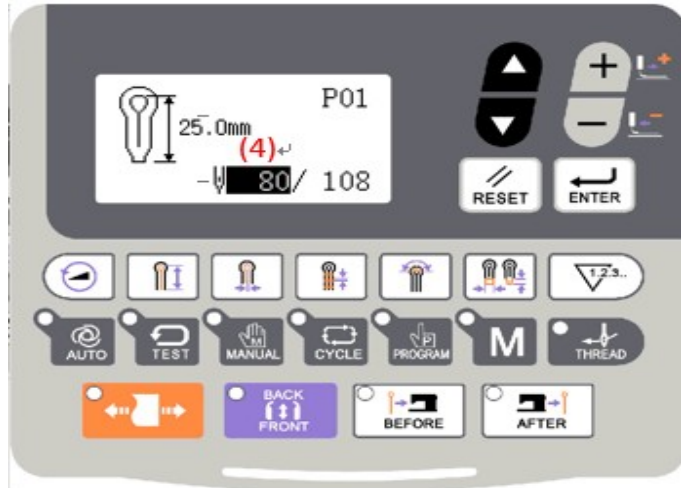

- ⑮ During the cloth-feeding, if user wants cloth-feeding board to return to the former sewing position:



Please press , 2 stitches will be returned at each pressing. The leftover stitch number (4) will add 2 stitches at each time.

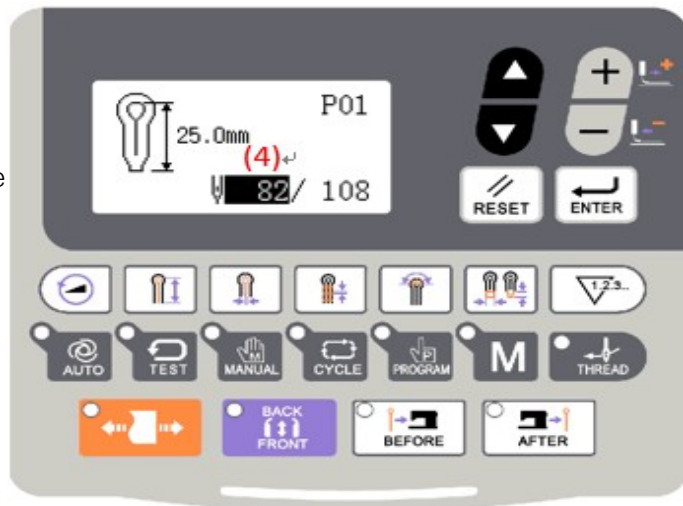

⑯ Last Stitch

Step Start Pedal (6) until the leftover stitch number turns to 0 and the cloth-feeding board returns to the position for setting cloth. After that, the pattern data area will display “END OF TEST FEED MODE”.

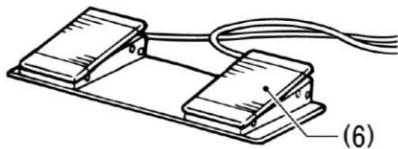

## 2.5 Shift of Cutter Actions

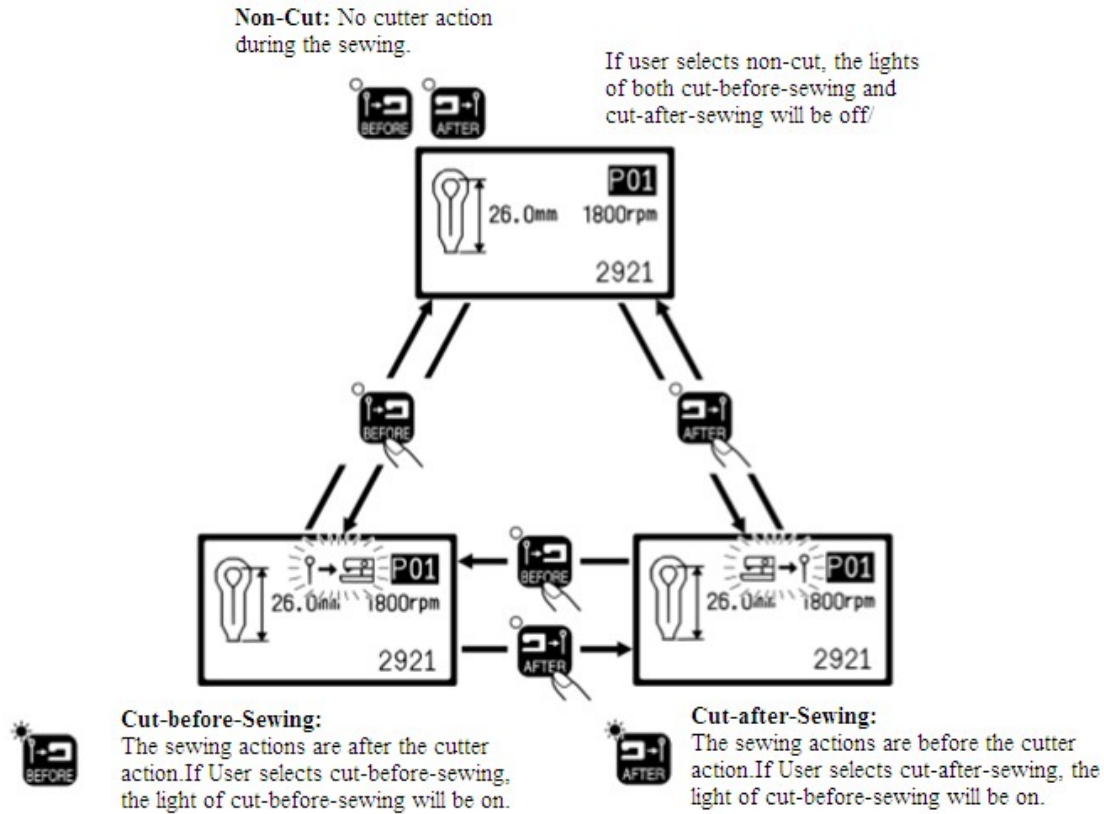

## 2.6 Method for Shifting Cloth Setting Position

Because this function can move the cloth-feeding board to a position more forward than standard position for setting cloth, the cloth setting is relatively easy. Especially at the status of Cut-after-Sewing, the time of the cycle is shortened.

### [Move the cloth-feeding board to the front]

In the standby status of Auto mode, Test Feed mode or Manual mode, press the FRONT/BACK key.

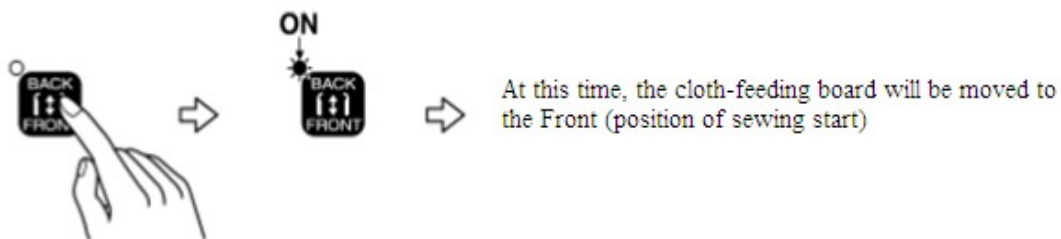

### [Move cloth-feeding board to the back (standard position for setting cloth)]

Press the FRONT/BACK key again.

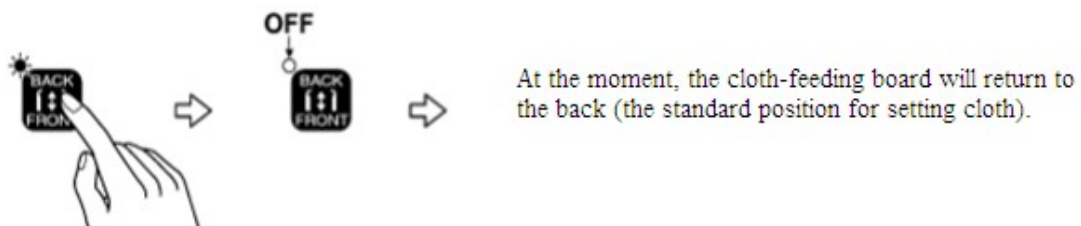

## 2.7 Threading Mode

This mode is used in threading the upper thread. At threading mode, if the Z axis of needle rod turns 180 degree, the excitation of stepping motors on X, Y and Z axis will be cut off. At this time, the needle rod and the cloth-feeding board can be moved freely so as to be easy for threading the upper thread.

### ④ Enter threading mode

In the standby status of Auto mode, Test Feed mode or Manual mode, press Threading Mode Key (1) to shift from cloth-feeding mode to threading mode. At this time:

1. The pattern data display area will display "Press 'RESET' to return to the previous interface" (2).
2. The thread-holder goes into open status.
3. The buzzer rings and the needle rod returns by 180°, then the excitation of the stepping motors on X, Y & Z axis will be cut off.

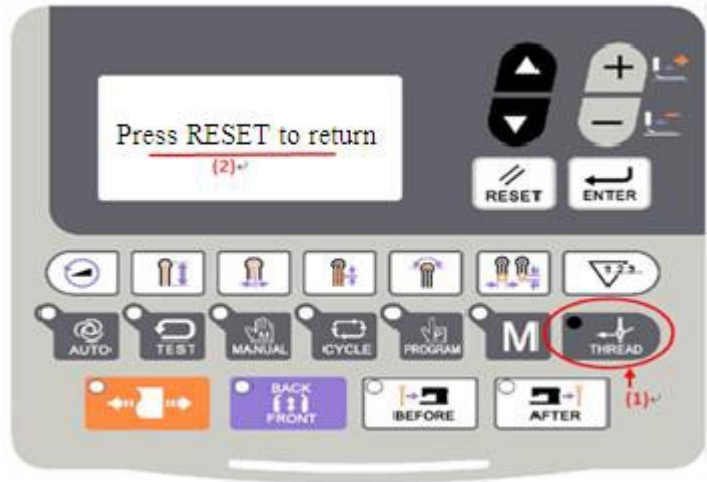

### ⑤ Threading Upper Thread

After 3 minutes, the thread-holder will be turned off automatically.

### ⑥ Finish of Threading Upper Thread

After threading the upper thread,

please press .

When the needle rod and the cloth-feeding board are moved to origin for origin test, they will return to the position for setting cloth.

The thread-holder is off

# 3 Instructions on Sewing Operations

## 3.1 Auto Mode



- In the case of automatic sewing for the first time, please perform the test sewing.
- When using MASC511 in the environment with low temperature, user shall perform the test sewing for several times, so as to warm up the motor.

⑦ Press Auto Mode Key

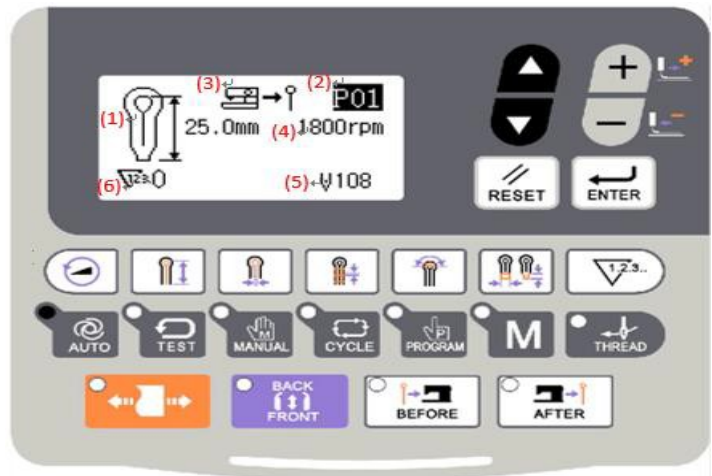
Press  to show the Shape



&  
Length of sewing stitch: Pattern Shape (1), Pattern Number (2), Cutter Action (3), Sewing Speed (4), Total Stitch Number of Current Pattern (5), as well as the Production Counter (6) at pattern data display area.

⑧ Press   to select the wanted pattern number (2). The pattern number will change in the following sequence: P01→P02→...P20→C1→C2...C9 at each pressing of .

Press  to change the number in the contrary direction.

⑨ Select the wanted action of cutter (Non-Cut / Cut-before-Sewing / Cut-after-Sewing).

Note: For the detailed shift method of Cutter Action, please refer to **【 2.5 Shift of Cutter Actions 】**

⑩ Lay the fabric for sewing under the presser, step the presser pedal (7).

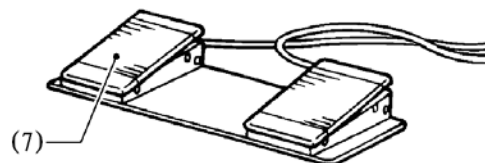

⑪ Step the start pedal (8) to start the sewing.

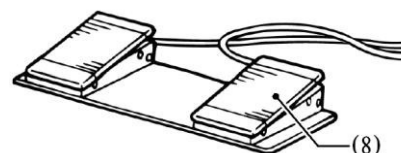

⑫ For sewing repetition, please repeat the operation of the above steps ④~⑤.



### 3.2 Manual Mode

<b>⚠ Caution</b>	
	For the cutter will act during the manual sewing, please keep hand away from the cutter. Otherwise the operator may suffer serious injury.

Under manual mode, turn the wheel to move the cloth-feeding board stitch by stitch. This will simplify the operation in synchronizing adjustment of yarn-divider.

- ⑧ Press Manual Mode 

Shape of Sewing Stitch Form (1), Pattern Number (2), Cutter Action (3), Total Stitch Number (4) and Leftover Stitch Number (5) are shown in the sewing data display area.

- ⑨ Press  to select the wanted pattern number (2).

The pattern number (2) will change in the following sequence: P01→P02→... P20 → C1

→C2...C9 at each pressing of .

( Press  to change the number in contrary direction. )

- ⑩ Lay the fabric for sewing under the presser, step the presser pedal (6) to lower the presser.

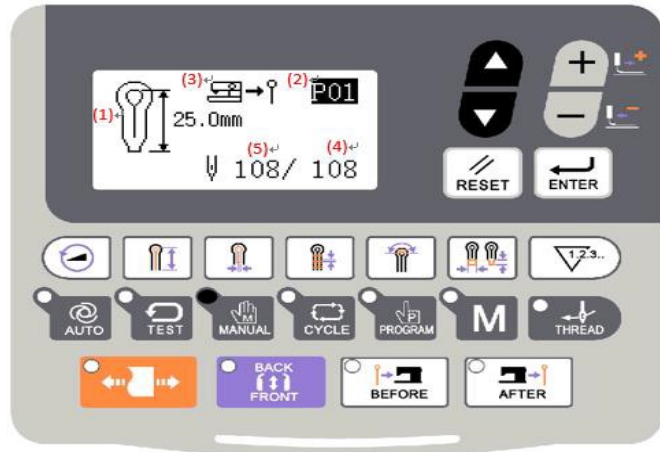

- ⑪ Step start pedal (7) to move the cloth-feeding board to the position of sewing start.

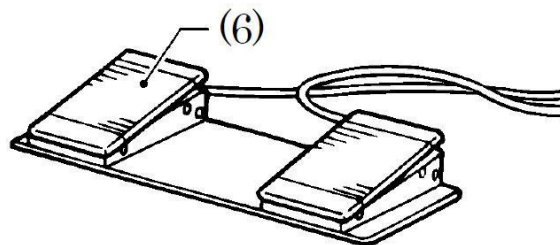

**Caution:** When setting the cutter action as “Cut-before-Sewing”, the operator shall look out for his hand at cutter moving.

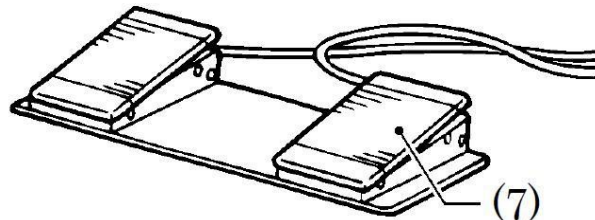

⑫ Turn Hand-wheel at Upper Axis to

Left

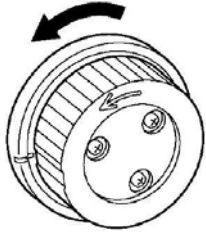

The cloth-feeding board will move to the sewing position of the next stitch at each turning round of upper axis hand-wheel. When the wheel reverses for half a cycle (needle rod goes up and down once), the leftover stitch number (5) at sewing data display area will reduce 1 stitch.

**Caution:**

If the upper axis hand-wheel turns reversely, the cloth-feeding board will not move the shape with the set stitch form. Please don't turn the wheel reversely.

⑬ For stopping the manual sewing, press emergence stop switch (8) when the cloth-feeding board returns to the position for laying cloth.

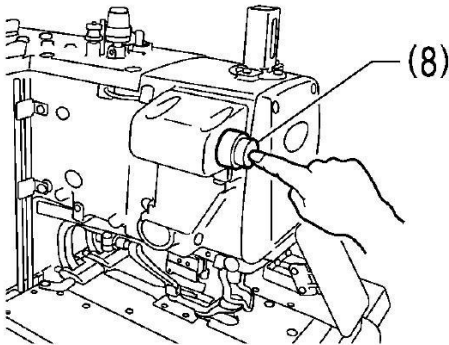

The "Pause Switch Is Pressed In Sewing" is displayed on operation board. Press



to release the alarm and return



to sewing interface and then press again.

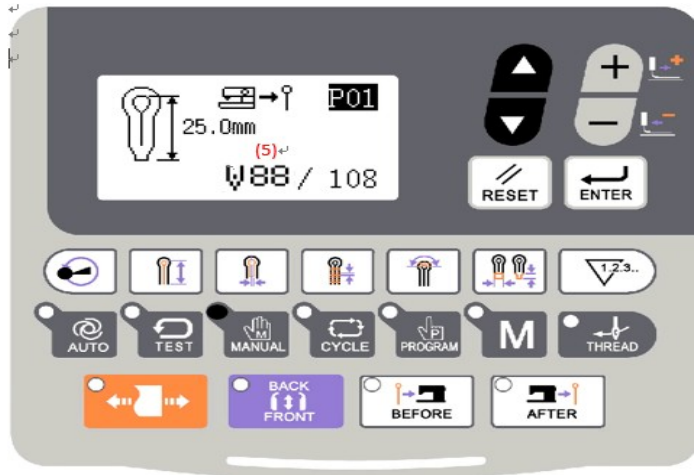

⑭ At Last Stitch

The needle rod stops at the upper position of the needle. Step start pedal (7) at this time.

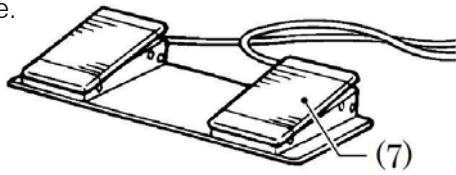

(Hold it until the cloth-feeding board returns to the position for laying cloth.)

In thread-trimming actions, when the cloth-feeding board returns to the position for laying cloth, the system will hint “END OF MANUAL MODE” in the operation panel.

**Caution:**

When setting cutter action as “Cut-after-Sewing”, user shall look out the action of cutter.

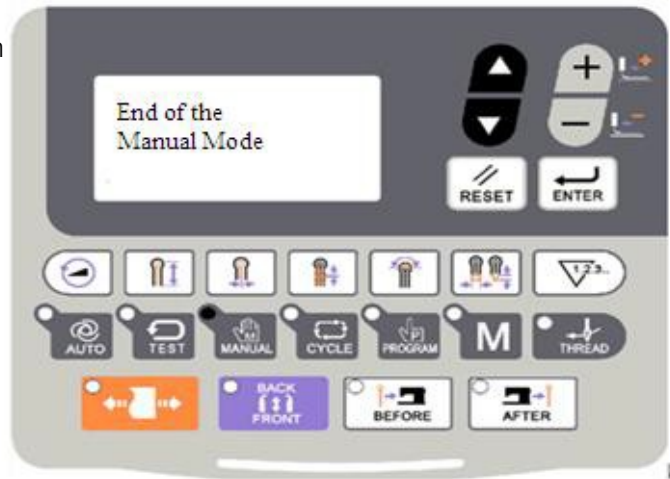

### 3.3 Pause Switch

#### Pause in Auto Sewing

The pause switch is generally used for stopping the sewing machine at thread-breakage and other circumstance.

#### 3.3.1 Methods for Pausing

During the sewing, press the pause switch (1) to stop the sewing machine, and then the operation panel will hint “Pause Switch is pressed under machine sewing status”.

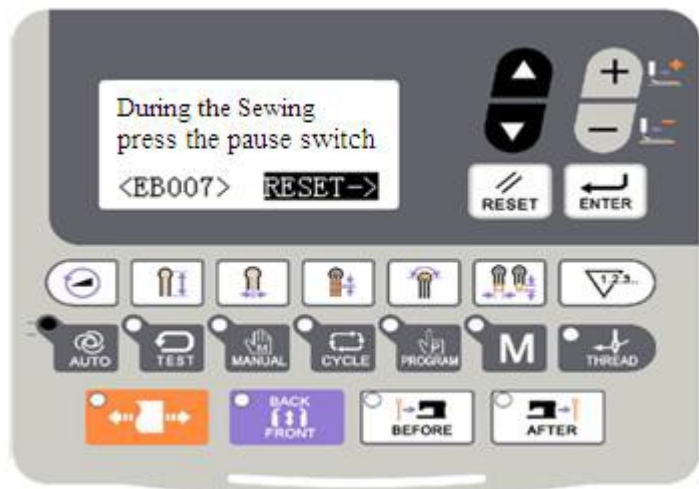
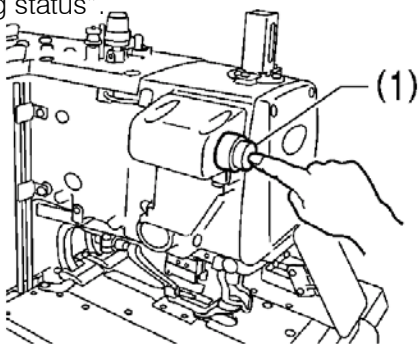

### 3.3.2 Method for Releasing Pause (Stopping the Work)

- ④ Press RESET (2) when the interface displays “Pause Switch is pressed under machine sewing status”.

Then the operation pedal will return to the sewing interface, and the pattern data display area shows “Press ‘Reset’ or ‘Down’”

- ⑤ Release the error causing the pause.

- ⑥ Press . After the needle rod and the cloth-feeding board performs the origin test, they will return to the position for setting cloth.

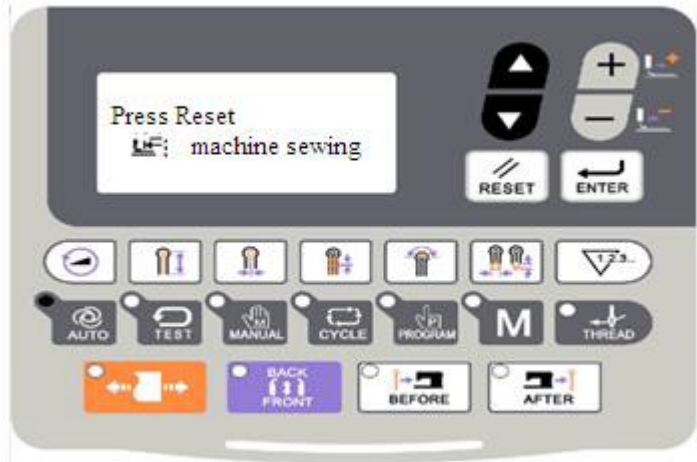





### 3.3.3 Method for Releasing Pause (Continuing the Work)



- ⑩ Press RESET (2) when the interface displays “Pause Switch is pressed under machine sewing status”.

Then the operation pedal will return to the sewing interface, and the pattern data display area shows “Press ‘Reset’ or ‘Down’”

- ⑪ Release the error causing the pause. If the upper thread is broken, press  to enter the threading mode.

- ⑫ Press  to display the total stitch number of pattern (3) and the leftover stitch number (4) in the pattern data display area.

- ⑬ Press  or  to move the cloth-feeding board according to the shape of pattern so as to confirm the position for continuing the sewing job. If the upper thread is broken, press  to enter the threading mode.

Note: press  to proceed and  to reverse. Holding means to keep proceeding or reversing.

- ⑭ Select the position for continuing the sewing, step the start pedal (5) to continue the automatic sewing of the existing pattern.

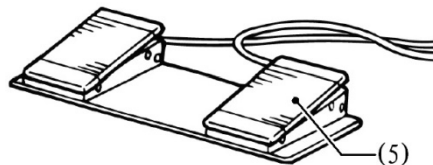
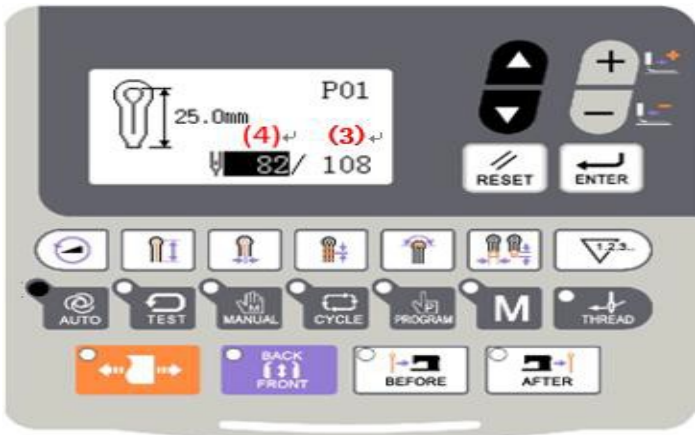

### 3.4 Usage Instructions on Cyclic Sewing Function

In the single pattern program (P01~P20), system can combine several edited single patterns together and register them into a “Cyclic Pattern Program” for continuous sewing, which is easy for using.

#### Cyclical Pattern Program :

Max Amount of Cyclic Patterns	9 個 (C01~C09)
Max Amount of Single Patterns in a Cyclic	9 個 (S1~S9) (A single P pattern can be selected for many

#### Example :



We select a single pattern P01 (3 steps, with cutter action) and a single pattern P03 (1 step, without cutter action) to combine a cyclical pattern, which is set as C1 for example

The set content of Cyclic Pattern Program C1:

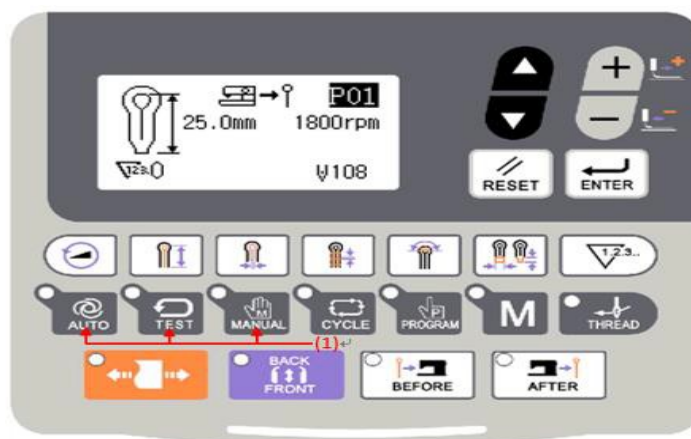
Step Number of C Pattern	S1	S2	S3	S4
Name of Single Pattern	P01	P01	P01	P03
Cutter Action	Yes	Yes	Yes	No



- ⑥ Press any key shown in area (1) of the right picture (take the auto mode as example).

- ⑦ Press   to select C1, the pattern number of that cyclical pattern program

The pattern number will change in the following sequence: P01 → P02 → ... P20 → C1 → C2 ... C9 ... P01 at each



pressing of . (Press  to reverse the sequence.)

- ⑧ Press Cycle Mode Key (2)

The sewing data display area will show the following contents:

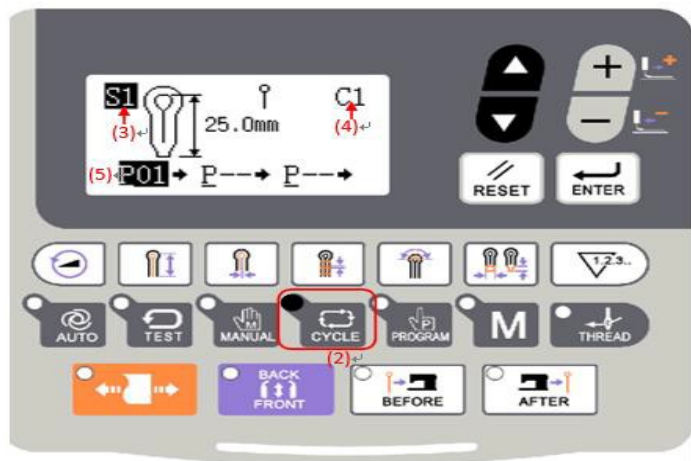
- (3) Step Number
- (4) Cyclic Program Number
- (5) Pattern Content Set in S1.



- ⑨ Press   to set the content of S1 (5) as P01

The underline “  ” in “P01” means that this pattern has the cutter action, therefore the cutter mark (6) is shown in the sewing data display area



“--” in “P--” means the pattern in this step has not been set yet.

If you set the existing pattern as “P--”, the content of the following steps will be deleted.

- ⑩ Press  to confirm the changed content.

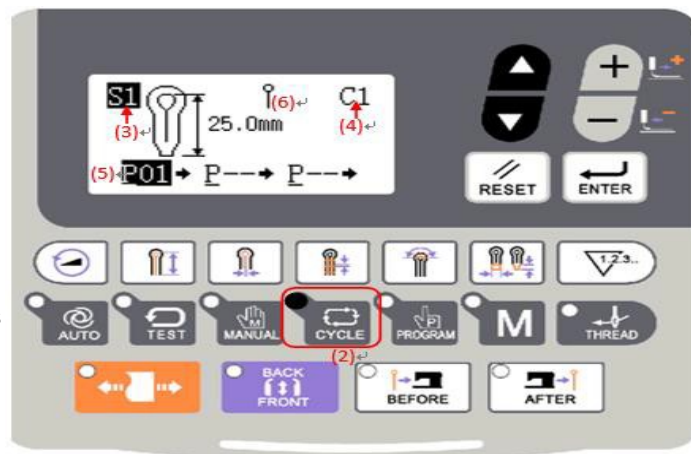
At that time, the content of S1 (5) will not be flashing any more.





- ⑮ Press   to change the step number (3) to S2.

⑯ Repeat the operations in the above steps 4 & 5 to set the content of S2 as “P01”, which is the same as that of S1. Also set the content of S3 as “P01”, which is the same as that of S1.

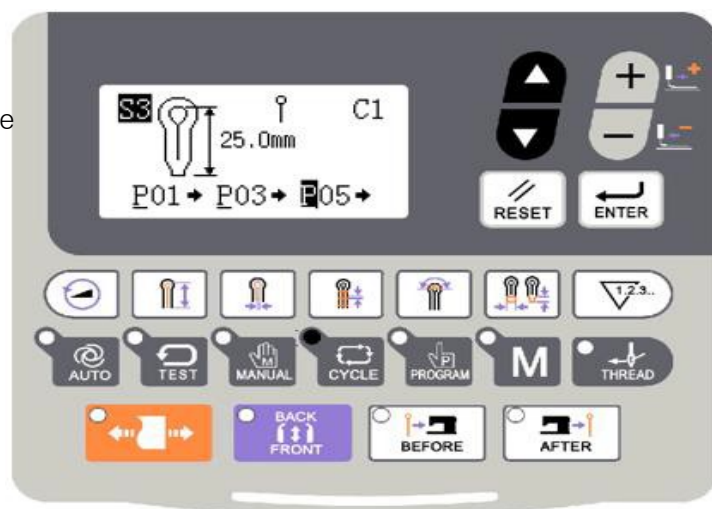
- ⑰ Press  to confirm the changed content.



⑱ Press  to change the Step Number (3) to S4.

Press  or  to set the content of S4 (6) as P03.

Press Cutter Action Key (7) to change the "P03" at position (6) to "P03" (Without Cutter Action).

⑲ Press  to confirm the changed content.

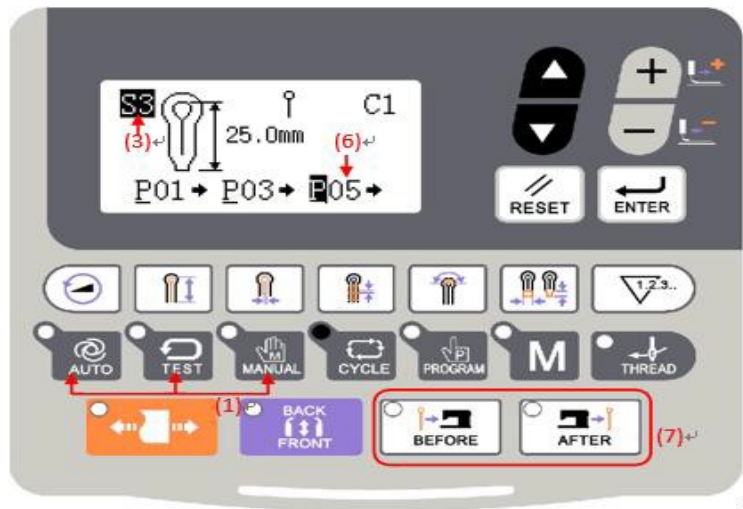

Press any key in (1) to end the setting in the Cycle Mode.

Note: When selecting the cyclical program to perform the automatic sewing, the user can change the cutter action in the Auto Mode. And the cutter action in the C pattern will be kept the same as set in the cutter mode.



## 4 Interface of Parameter Setting Mode

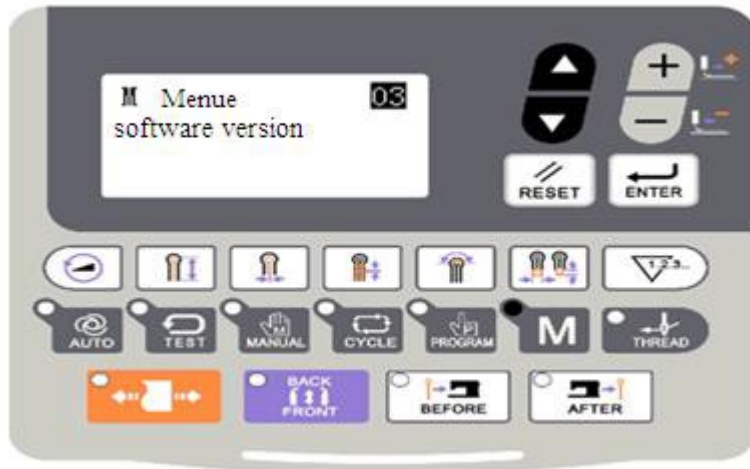

In the interface for inputting sewing data, press  to shift the data input interface and parameter setting mode interface (as shown in right picture). In the interface of parameter mode, user can make some detailed settings and editions.

In the interface for inputting sewing data, press ,  or  to quit the parameter setting mode and return to the auto sewing mode, test sewing mode or manual mode.



Setting Mode

### 4.1 Description of Functions

After entering the parameter setting mode, user can press  or  to select the function to be set and press it. Functions to be selected include:



No.	Functions
1	Parameter setting
2	Recovery to default setting
3	Inquiry of software version.
4	Software update
5	System detection



## 4.2 Software Version Inquiry

In the Setting Mode, press  or  until the option "Software Version" is displayed

and press  to enter software version inquiry interface (as shown in the right picture). Under this interface,

press  or  to check the version of main control, control panel and stepping program

respectively; press  to quit this function.

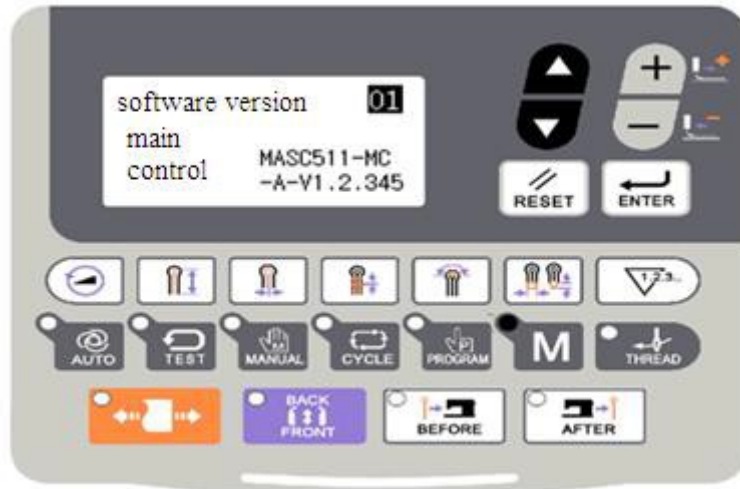

## 4.3 Software Update



Support update via U disk.

### (1) Main Control Update

**Step 1:** first create a file folder named "update" under the root directory of the U disk, and then put the main control program "mControl" under that "update" file folder.

**Step 2:** connect the U disk to the operation panel and then

press  to enter parameter setting mode where user can

press  or  to make the system display "software

update" and press  to select it.

**Step 3:** press  to make the update. After the the panel

displays update is complete, turn off the power and restart the machine to finish the update operation.

**Note:** the power shall remain on during the update process until the update is completed and the system hints to restart the system.

**(2) Panel Update**

**Step 1:** first create a file folder named “update” under the root directory of the U disk, and then put the panel program “LCDpanel” under that “update” file folder.

**Step 2:** before powering on, first insert the U disk containing the panel update program. After that,



press



the

keys , and on the panel at the same time and then start the machine. The panel will directly enter and display the panel update mode.



**Step 3:** press to enter the update status automatically. After the panel displays update is complete, turn off the the machine and power it on again to finish the update operation.

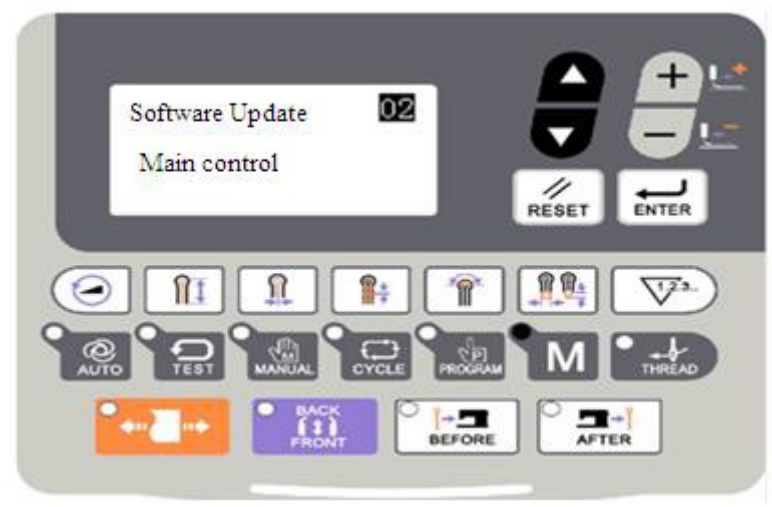
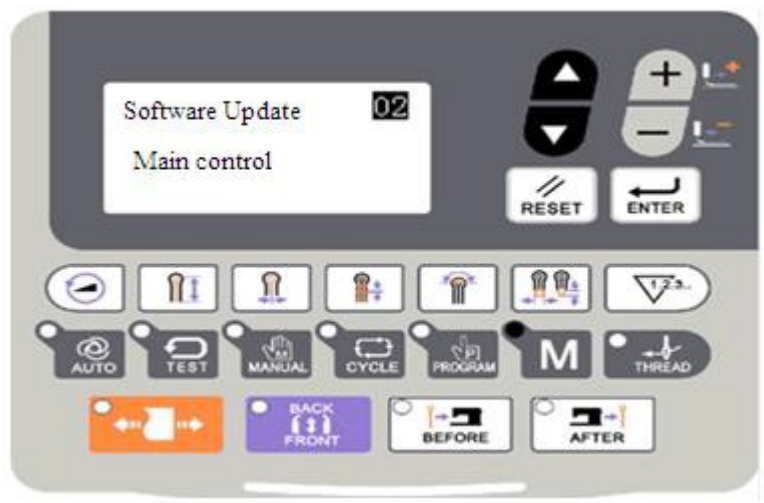

**Note:** the power shall remain on during the update process until the update is completed and the system hints to restart the system.



## 4.4 Parameter Setting

In the setting mode, press   to select



“parameter setting” and press   to enter the interface for setting U level parameters (as shown in right picture).

Press  to quit the setting interface.

Press  or  to select the

parameter for changing; then press  or

 to change



the value of the parameter and  press

to confirm the change. Pressing  or

is to change the parameter and at that time the ground color of the parameter value will turn white; after user presses  to confirm the change, the ground color will turn black.

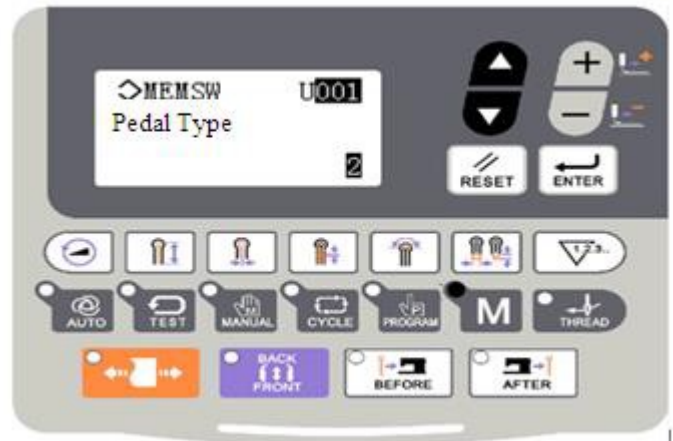

Parameter under Setting



Parameter after Confirmation

### List of U Level Parameters:

No.	Functions	Description	Range	Changing Step	Default Setting
U001	1 Pedal/2 Pedals Switch	0: Analog single pedal 1: Step the start pedal to lower the presser, and the sewing machine starts. 2: Press the presser switch to lower the presser. Then step	0~2	1	2
U051	Delay time before cut for 1 Pedal model	For automatic sewing in Cut-before-Sewing mode, this parameter will determine the	0~800	50ms	0

No.	Functions	Description	Range	Changing Step	Default Setting
		the pedal 1 is stepped			
U056	Lower presser when move front	0: OFF After sewing, the cloth-feeding board moves to the position set before with the presser at up position; the presser keeps up during searching origin. 1: ON After sewing, the presser doesn't rise until the cloth-feeding board moves to the position for laying cloth; during the process of searching origin, the presser keeps	0~1	1	0
U057	Enable presser at test	0: OFF The raise of presser is forbidden in test mode 1: ON In Test mode, the following operations can make presser go up: (A): Manual switch type or double pedal type: press presser switch (B): pedal type : return to pedal In restarting the test mode, the following operations have to be done for lowering the presser (A): Manual switch type or double pedal type:	0~1	1	0
U058	Presser action after sewing	0: Up Presser goes up when the automatic sewing is finished 1: Down Presser keeps going down when the automatic sewing is finished. Please perform the following operations when the presser rise: (A): Manual switch type or double pedal type: press presser switch	0~1	1	0
U150	Stop at needle upper position when suspended	OFF: At pause, the upper axis is in the status of emergency stop ON: At pause, the upper axis stop at needle upper	0~1	1	1
U152	Final stch spd of	Set speed of the last stitch	700~90	10rpm	800

No.	Functions	Description	Range	Changing Step	Default Setting
	main shaft		0		
U153	Last speed of main shaft	Set the stop speed	250~450	10rpm	350
U156	Stop angle of main shaft	The stop control section will be prolonged when this value goes up.	2.5~17.5	0.5°	11.0
U256	Interval of origin detect	0: OFF Do not detect origin after sewing 1~9: Detect the origin position after sewing in	0~9	1	0
U301	Parameter column in Auto Mode	1: Sewing length 2: Interval	1~2	1	1
U350	Forbid Program Mode	0: OFF General Conditions 1: ON Forbid to enter program mode, the hotkeys are	0~1	1	0
U351	Forbid Cycle Mode	0: OFF General Conditions 1: ON Forbid to enter cycle mode	0~1	1	0
U352	Forbid to change counter	0: OFF General Conditions 1: ON Forbid to change the value in products counter	0~1	1	0
U353	Forbid to edit sewing speed	0: OFF General Conditions 1: ON Forbid to change the sewing speed	0~1	1	0
U354	Forbid to edit the program number	0: OFF General Conditions 1: ON Forbid to change the program number, but the step number in cycle can be	0~1	1	0
U355	Forbid to change Cut-before-Sewing	0: OFF General Conditions 1: ON Forbid to change the action of Cut-before-Sewing (If existing status is Cut-before-Sewing, it will change to Non-cut automatically.)	0~1	1	0
U356	Forbid to change Cut-after-Sewing	0: OFF General Conditions 1: ON Forbid to change the action of Cut-after-Sewing (if existing status is Cut-after-Sewing, it will change to Non-cut automatically)	0~1	1	0
U357	Safety Switch	0: OFF Safe Switch Invalid	0~1	1	1

No.	Functions	Description	Range	Changing Step	Default Setting
		1: ON Safe Switch Valid			
U358	Pressure Detection	0: Pressure detection open 1: Pressure detection closed	0~1	1	1
U450	Max sewing speed	Set the Max sewing speed	1000~2700	100rpm	2700
U451	Max cycle program number	Number of effective cycle program number (if user doesn't use the cycle program number, this parameter can be	0~9	1	9
U452	Product count for cycle pattern	0: OFF Count after sewing a hole 1: ON Count after sewing a cycle	0~1	1	0
U453	Max cutter interval	Set the max cutter interval	0.5~1.0	0.1mm	0.5
U454	Max linear bar-tacking length	Set the max length of linear bar-tacking	6~9	3	6
U455	Additional needle swing at Non-cut	If the Non-cut is used, the needle swing will be added automatically.	0~1.0	0.1mm	0
U456	Adjustment of needle swing at	Set adjustment of needle swing	-1.0~0.0	0.1mm	0
U550	Time for air-hammer ON	The larger the value, the longer the contact time between air-hammer	25~200	5ms	25
U551	Air-hammer origin height	In readiness status, Error number E650 will be activated when the value of air-hammer position sensor is smaller than this value (only effective when the air-hammer origin error	150~170	1	160
U552	Air-hammer origin error detection	0: OFF No air-hammer origin error detection (used when the air-hammer position sensor is broken down.) 1: ON Have air-hammer origin	0~1	1	1
U553	Determine air-hammer rise position by time	0: OFF According to position of air-hammer to detect the lowering of air-hammer 50~500: Detect the lowering of air-hammer according to time (used when the air-hammer position sensor is	0~500	10	0
U554	Determine air-hammer lowering by time	0: OFF Determine the position of air-hammer for lowering. 50~500: Detect the lowering of the air-hammer according	0~500	10	0



No.	Functions	Description	Range	Changing Step	Default Setting
		air-hammer position sensor is broken down.)			
U555	Increase of leftover upper thread	0: OFF General Conditions 1~3: Because only the sequence delay of trimming upper thread is set, the leftover upper thread may be	0~12	1mm	0
U556	Time for loosing upper thread	The larger the value, the longer the time for loosing upper thread after thread-	0~100	2ms	50
U557	Upper thread-loosing Off Sequence	0~100: the larger the value, the later the thread-loosing OFF	0~100	2ms	50
U558	Forbid to use bottom thread trimmer device	0: OFF General Conditions (Bottom thread trimmer device is activated ) 1: ON Forbid to use bottom thread trimmer device	0~1	1	1
U559	Neglect of bottom thread cutter sensor and counter	0: OFF Detect the bottom thread cutter device is off according to the OFF sensor of bottom thread trimmer 5~50: Detect the bottom thread cutter device is off according to time. Set this	0~50	5ms	0
U560	Bottom thread-trimming time	0~100: the larger the value, the later the thread-trimming time.	0~100	1	0
U561	Upper thread-breakage	0: OFF Device Invalid 1: ON Device Valid	0~1	1	0
U562	Start stitch number before upper thread-breakage	1~9: Sew the set stitches before the upper thread-breakage detection.	1~9	1	5
U563	Stitch number before upper thread-breakage	2~7: When the thread-breakage signal turns ON at the set stitches, the Error of thread-breakage will be	2~7	1	4
U564	Upper thread-catching	0: OFF Device Invalid 1: ON Device Valid	0~1	1	0
U565	Upper thread-catching close time correction	-10~10: the larger the value, the later the upper thread-catching will be.	-10~10	1	0
U576	Upper thread-catching	5~20ms: set in unit of 1ms	5~20	1	10

No.	Functions	Description	Range	Changing Step	Default Setting
	open time				
U577	Frame-moving Method	0~5: select different frame-moving method	0~5	1	1
U578	Frame-moving adjustment 1	-50~50: Adjust the XY frame-moving angle	-50~10 0	1	0
U579	Z axis frame-moving adjustment	-50~50: Adjust Z axis frame-moving angle	-50~50	1	0
U580	Upper thread taking-up action time	0~200: Start time adjustment of upper thread taking-up	0~200	5	0
U581	Upper thread tension adjustment	0~250: Adjust upper thread solenoid current	0~250	5	230
U651	Motor excitation status at error	0: OFF At unrecoverable problem, the excitation of pulse motor will be off. 1: ON At unrecoverable problem, the excitation of pulse motor	0~1	1	0
U752	Adjustment of X position on cutter	The set value is the adjustment of X position on cutter, which will be added into entire pattern program.	-0.50~0 .50	0.05mm	0
U850	Sewing machine head configuration	0: -00 Set configuration as -00 1: -01 Set configuration as -01 2: -02 Set configuration as -02	0~2	1	0
U852	Radial Hole Presser	0: OFF Use general presser (except that of radial hole) 1: ON Use the special program for radial hole presser. The displayed is the special parameter for radial hole.	0~1	1	0
U853	Language	0: Chinese 1: English	0~1	1	0
U854	Back light auto Off	0: OFF No auto off 1: ON Auto off	0~1	1	0
U855	Backlight auto off waiting time	Set the waiting time of the backlight auto off	1~9	1 min	3
U856	Button display style	0: Sty1 Style 1 1: Sty2 Style 2	0~1	1	0
U857	Voice Volume	30~63: adjust the volume of voice	30~63	1	50
U911	Cutter position adjustment	Set the value of cutter position adjustment	0~60	1	15
U912	Main motor type	0: 360 wire motor 1: 256 wire motor	0~1	1	0



No.	Functions	Description	Range	Changing Step	Default Setting
U913	DIP1	Temporary adjusting parameter	-100~100	1	0
U913	DIP2	Temporary adjusting parameter	-100~100	1	0

#### 4.5 Initialization of Parameters

In the setting mode, press  or  to

select “parameter initialization” and press  to enter the interface of U level parameter setting.

Press  to quit the parameter setting interface.

After entering the parameter setting mode, user can select:

(1) LEVEL1: Pattern And C Program (S Level pattern parameter and C pattern cycle program) (2) LEVEL2: Storage Data (Including U level

parameters)

(3) LEVEL3: All Internal Data

The detailed initialization content is at below:

	LEVEL1	LEVEL2	LEVEL3
Program content	Default value	—	Default value
Cycle program	Clear	—	Clear
Storage switch	—	Default value	Default value
Program number	1	—	1
Parameter number	1	—	1
Production counter	—	—	0
Mode	Program	—	Program
Position for laying cloth	Inside	—	Inside
Cutter action	OFF	—	OFF

② Select the parameter for initialization, then press

 for confirmation.

The right interface will be displayed on the

screen, press  to initialize the parameter

or press  to cancel the initialization operation.

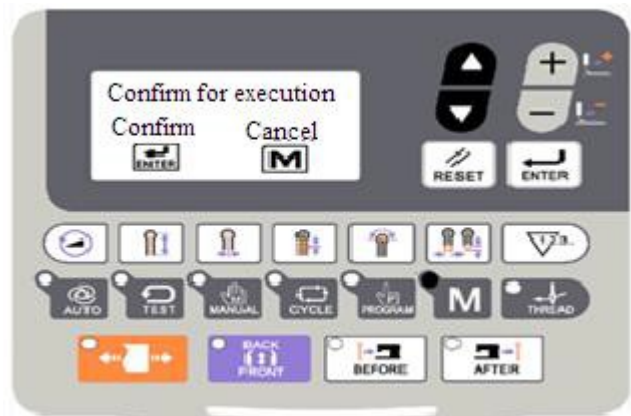
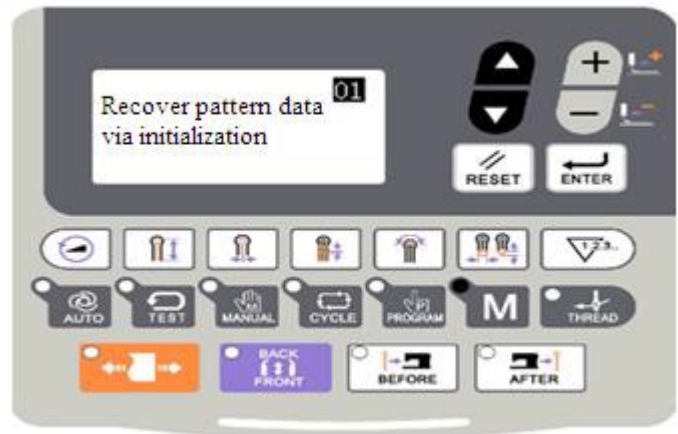



## 4.6 System Detection

This function is mainly used for debugging the machine and the controller. In setting



mode, press  or  to select

“system detection” and press  to enter the interface of U level parameter setting.

Press  to quit the system detection interface.

In the system detection mode, press  or  to select:

- (1) Input detection, which is mainly used to detect the switch signal of the sensors;
- (2) Output detection, which is mainly used to detect the control condition of motors, valves and other devices;
- (3) Rotation detection, which is mainly used to detect the working status of the main shaft motor;
- (4) Aging mode, which is mainly used to test the running of the machine;
- (5) Main shaft adjustment, which is used for the adjustment of main shaft angle.

Press  to enter the selected function, and press  to quit the current detection interface.

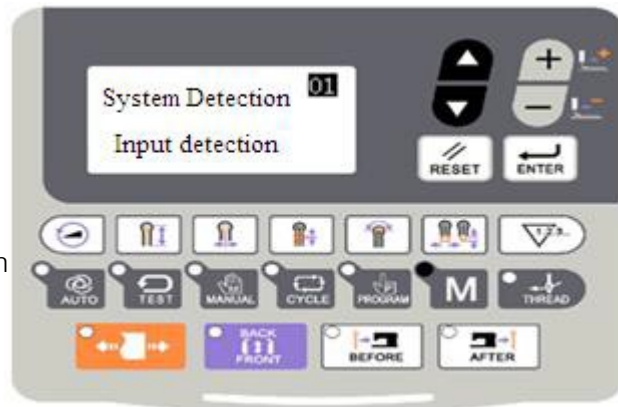

## 5 Appendix 1

### 5.1 List of Warning Information

Malfunction number	Name of Malfunction	Method for Settlement
<b>System Malfunction</b>		
E-001	IPM over-voltage or over-current	Turn Off Machine
E-002	Supplementary device (24V) over-voltage	Turn Off Machine
E-003	Supplementary device (24V) low-voltage	Turn Off Machine
E-004	EEPROM Error	Turn Off Machine
E-005	Motor running error	Turn Off Machine
<b>Special Malfunction</b>		
E-006	Press Pause key at standby status	Release pause key
E-007	Press Pause key at sewing status	Press RESET
E-008	Pause Key bad connection	Turn Off Machine
E-009	Start Switch is held or bad connection	Release the start switch or turn off machine. And check the connection
E-010	Presser Switch is held or bad connection at presser switch	Release the start switch or turn off machine. And check the connection
E-011	Machine head is tilted.	Turn Off Machine
E-012	Needle upper position abnormal	Turn wheel to upper position
E-013	Synchronization signal detector bad	Turn Off Machine
E-014	Cannot find X feeding motor origin. X feeding motor abnormal or bad connection at X origin sensor	Turn Off Machine
E-015	Cannot find Y feeding motor origin. Y feeding motor abnormal or bad connection at Y origin sensor	Turn Off Machine
E-016	Cannot find $\theta$ feeding motor origin. $\theta$ feeding motor abnormal or bad	Turn Off Machine
E-017	IPM Over-current	Turn Off Machine
E-018	IPM Over-current	Turn Off Machine
E-019	Program version of main controller or	Turn Off Machine
E-020	Upper thread-breakage	Press RESET
E-021	Bottom thread-trimming device not work or bottom thread-trimming sensor abnormal	Turn Off Machine
E-022	Hammer is lowered or hammer position sensor is abnormal	Turn Off Machine
E-023	Hammer is not lowered or hammer	Turn Off Machine
E-024	Power over-voltage	Turn Off Machine
E-025	Stepping motor over-voltage	Turn Off Machine
E-026	Power low-voltage	Turn Off Machine
E-027	Stepping motor over-current	Turn Off Machine

Malfunction number	Name of Malfunction	Method for Settlement
E-028	Cooling fan not work	Turn Off Machine
E-029	Hammer cannot go down	Turn Off Machine and Increase Cutter
E-030	Stepping board communication abnormal	Turn Off Machine
E-031	X motor running abnormal	Turn Off Machine
E-032	Y motor running abnormal	Turn Off Machine
E-033	Cloth board over-range	Turn Off Machine
E-034	Z motor running abnormal	Turn Off Machine
E-035	Motor close-loop abnormal	Turn Off Machine
E-036	Main-shaft 0 position signal error	Turn Off Machine
E-037	Main-shaft encoder error	Turn Off Machine
E-038	Main-shaft stop abnormal	Turn Off Machine
E-039	Sewing stop abnormal	Turn Off Machine
E-040	SPI communication busy	Turn Off Machine
E-041	Stitch signal error	Turn Off Machine
E-042	X motor busy	Turn Off Machine
E-043	Y motor busy	Turn Off Machine
E-044	Z motor busy	Turn Off Machine
E-045	Pattern stitch number error	Turn Off Machine
E-046	Main-shaft speed abnormal	Turn Off Machine
E-047	No encryption device	Turn Off Machine
E-048	Wrong password 1	Turn Off Machine
E-049	Wrong password 2	Turn Off Machine
E-050	Low pressure	Turn Off Machine
E-051	X motor over-current	Turn off machine and check X motor
E-052	Y motor over-current	Turn off machine and check Y motor
E-053	X motor position error	Turn off machine and check whether the machine is stuck in the X direction
E-054	Y motor position error	Turn off machine and check whether the machine is stuck in the Y direction
E-055	X motor over-speed	Turn off machine
E-056	Y motor over-speed	Turn off machine
E-057	MD1 communication error	Turn off machine
E-058	Z motor over-current	Turn off machine and check Z motor
E-060	Z motor position error	Turn off machine and check whether the machine is stuck because Z axis
E-062	Z motor over-speed	Turn off machine
E-064	MD2 communication error	Turn off machine

## 5.2 Hint List

No.	Name	Content
M-001	System parameter error	
M-002	Panel data storage error	
M-003	Panel and main board communication	
M-004	Create data failed	Memory full
M-005	Create data error	Computing error
M-006	Data transmission error	
M-007	Machine head parameter error	
M-008	Counter error	
M-009	Counter exhausted	Please
M-010	Wrong machine type	
M-011	Wrong manufacturer	
M-012	Parameter input/output failure	

## 5.3 Malfunction Settlement

Malfunction	Reason	Solutions
Thread-breakage	Thread-tension is so high.	Adjust the thread-tension to proper
	The needle is not properly installed.	Install the needle in the right direction
	Compared to needle, the thread is so	Select the thread fitting to the needle
	The needle doesn't match to the bend needle.	Adjust the pitch between the needle land bend needle, as well as the height of needle rod, bend
	There is damage or rags on needle, bend needle, yarn divider,	Polish or replace the rough parts.
	Threading method is wrong.	Thread correctly.
Needle-jumping	The upper thread tension is too large	Adjust the upper thread tension to a
	The needle tip is broken or crooked.	Replace for a new needle
	The interval between needle and bend needle tip is incorrect.	Adjust the interval between the needle and the bend needle tip
	The needle, bend needle and yarn	Adjust the relationship among these
	The needle and needle stand are not	Properly adjust the needle stand.
	The bend needle tip is blunt.	Polish it or replace it.
	The needle is not properly installed.	Install the needle in right direction.
The needle is too thin.	Select needles fit for the sewing	
Needle-breakage	The needle is crooked	Replace a new needle
	The needle, bend needle and yarn	Adjust the relationship among these
	The needle and needle stand are	Properly adjust the needle stand.

	adjusted properly.	
	The needle is too thin.	Select needles fit for the sewing
Upper thread is not cut off.	The upper cutter is not so sharp	Replace a new upper cutter
	The pressure is too low to let upper	Adjust the pressure
	The upper cutter can't catch the upper thread.	Install a upper thread bend needle, and cut the thread at the stitch
	At the last stitch, the upper cutter can't catch the upper thread due	Refer to "Needle-jumping", try to avoid the needle from jumping
	The position of upper cutter is	Adjust the position of upper cutter
Bottom thread is not cut off.	The cutter is not so sharp.	Replace a new cutter.
	The pressure is too low to let upper	Adjust the pressure
	The position of cutter is improper	Adjust the position of the cutter and
	The pressure on cutter for trimming	Adjust to a proper cutter pressure
Stitch-missing at sewing start	Can't hold bottom thread.	Adjust the bottom thread holder (configuration 01) or bottom
	The leftover part of the upper thread	Adjust the assistant thread holder.
	The released upper thread is far from	Adjust the amount of released upper
Cutting function abnormal	Low pressure on cutting device	Adjust the pressure to a proper level
	Cutter doesn't properly connect with	Polish the surface of cutting hammer
	The cutter is not so sharp.	Replace a new cutter.
Low thread density	The tension of upper thread is so	Adjust the upper thread tension to a
	The tension of bottom thread is so	Adjust the bottom thread tension to a
	The strength and stroke of take-up	Adjust the strength and stroke of

## 6 Appendix 2

### 6.1 Installation Size of Operation Panel

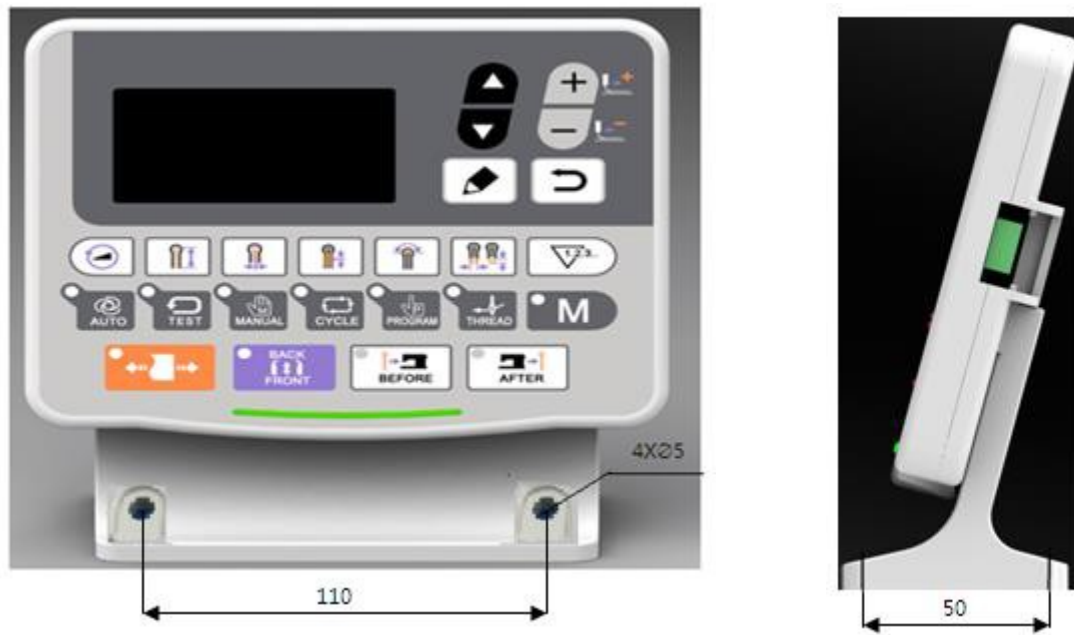
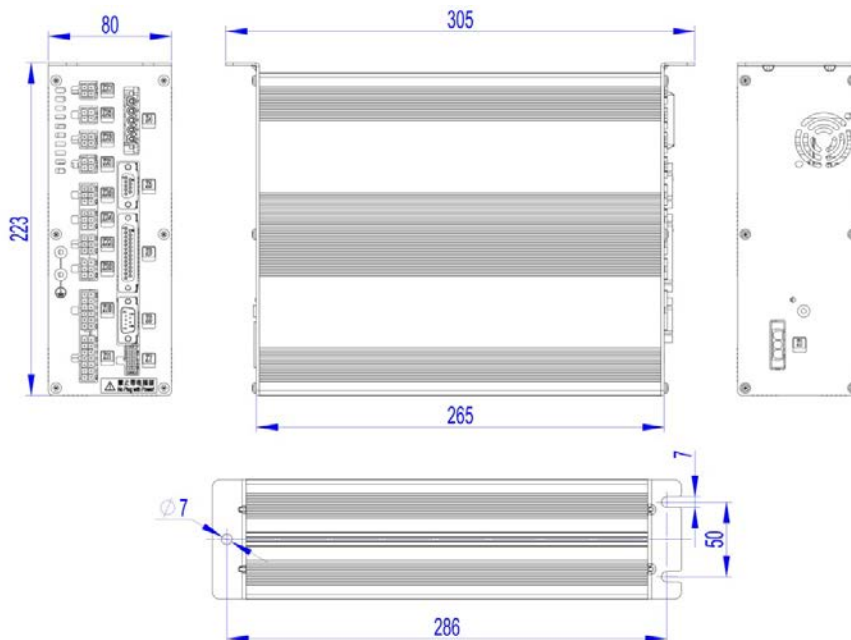

Figure 4 Installation Size of Operation Panel

### 6.2 Installation Size of Control Box0



## 6.3 Diagram of Connection of the External Cable and Control Box

Please check the corresponding symbol on both the external cable and control box. Follow the symbol to make the connection.

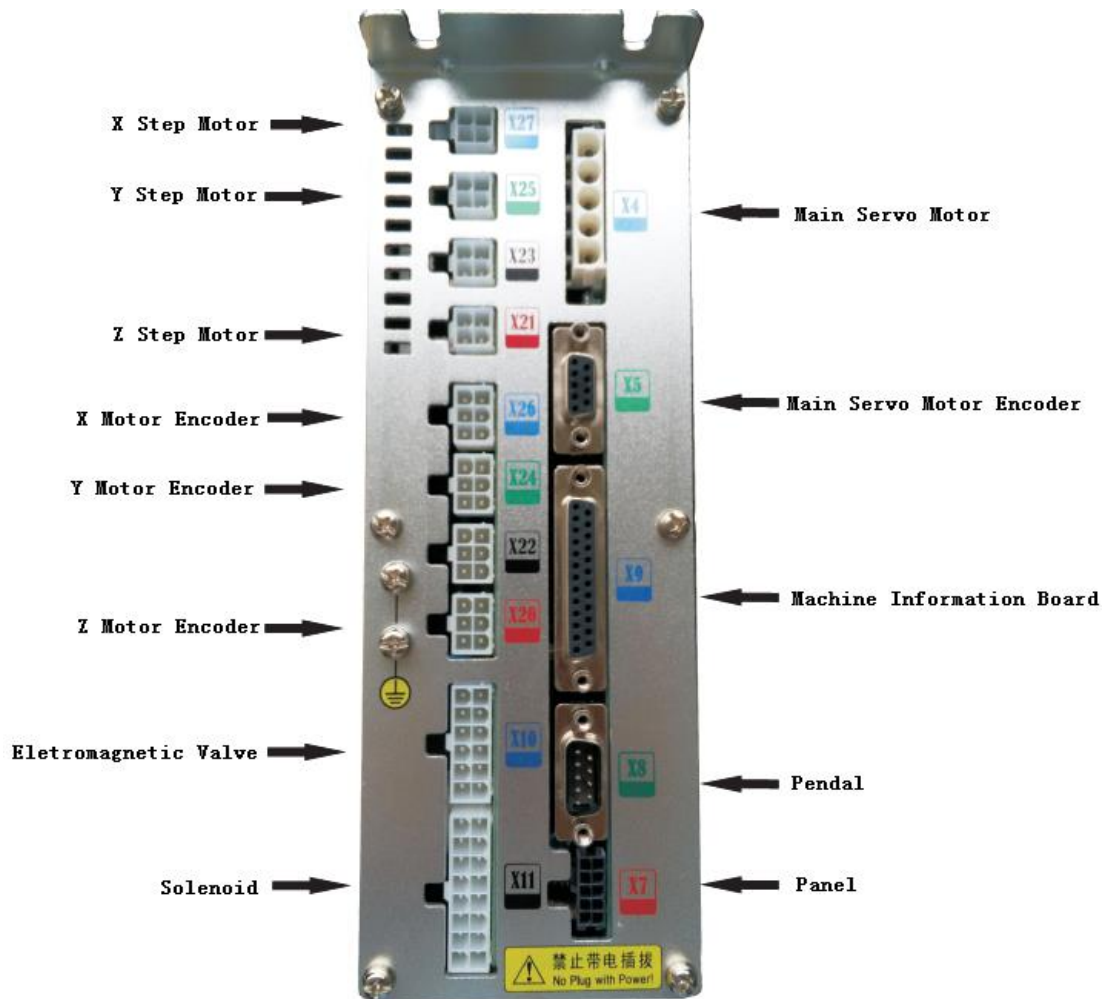



# 6.4 MASC511 Eyelet Buttonhole Machine System Diagram

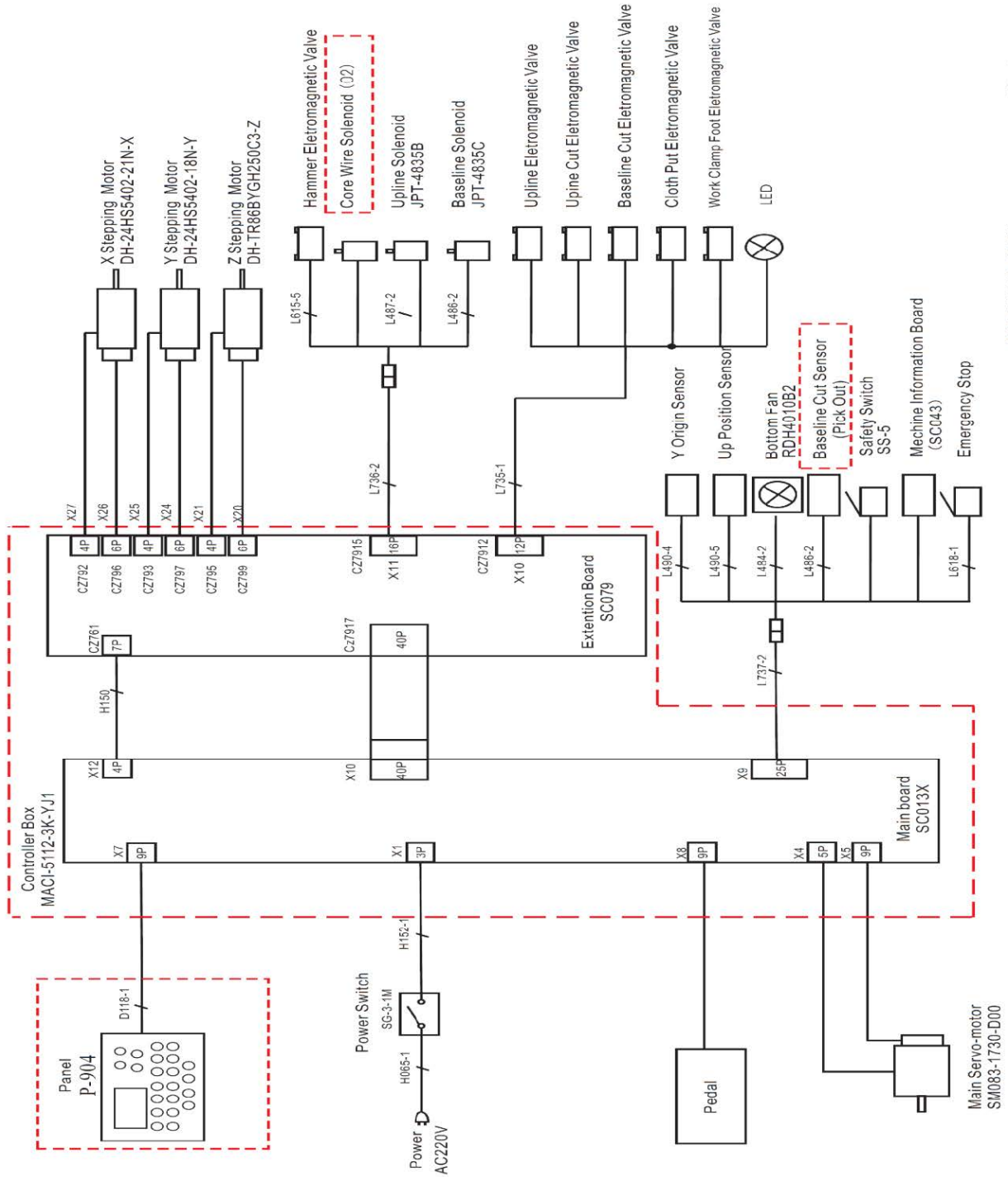



中文

中文

## 一般安全聲明

由於縫製作業的具體情況，有時不得不靠近機器轉動的零部件進行操作而有可能接觸到轉動零部件，因此實際操作機器的操作員和維修保養的維修人員，必須在事前仔細閱讀有關安全的注意事項，充分理解內容之後再進行操作。此有關安全的注意事項中記述的內容有的不是使用者購買的商品規格的內容。

另外，為了能讓用戶充分地理解使用說明書以及產品的警告標籤，特將警告表示分為如下種類。請充分瞭解這些內容，並遵守指示的要求。

經理及主管有責任讓他們的同事在操作前完全理解。

沒有遵守本手冊中列出的說明可能導致嚴重傷害甚至死亡，以及財產損失。

### 警告圖示表示和指示標籤的說明

 <p>高壓電危險 DANGER 注意：關閉電源10分鐘後再打開箱蓋 TO OPEN THE COVER TURN OFF POWER SUPPLYING AND WAIT MORE THAN 10 MINUTES BEFORE OPENING.</p>	<p>高壓部位 務必關閉電源 10 分鐘後 始打開電控箱蓋子</p>	 <p>Be careful of its movement. 移動快速 敬請小心</p>	<p>高速運動部位 謹防工傷事故</p>
 <p>CAUTION 機械作動部份請注意 保護裝置 穿線、換線、調整、清潔 時請注意關閉電源。 Moving parts may cause injury. Operate with safety devices. Turn off main switch before threading, changing bobbin and needle, cleaning etc.</p>	<p>高速運動部位 謹防工傷事故</p>		<p>高速運動部位 謹防工傷事故</p>

警告圖標表示		警告圖標表示	
	<p>有接觸轉動部，造成受傷的危險。</p>		<p>作業時拿縫紉機的話，有讓手受傷的危險。</p>
	<p>有接觸高電壓部，造成觸電的危險。</p>		<p>有捲入皮帶，造成受傷的危險。</p>
	<p>有接觸高溫部，造成燙傷的危險。</p>		<p>觸摸了鈕扣傳送器，有受傷的危險。</p>
	<p>如果直接目視鐳射的話，有傷害眼睛的危險。</p>	指示標籤	
	<p>有頭部接觸到縫紉機的危險。</p>		<p>指示正確的轉動方向。</p>
			<p>指示地線的連接。</p>

## 有關安全的注意事項

### 危險

事故：是指給與人身以及財產帶來損害。

需要打開電氣箱時，為了防止觸電事故，請關閉電源，經過 5 分鐘以上的時間之後再打開電氣箱蓋。

### 注意

#### 1. 基本注意事項

- (1) 使用之前，請您一定要閱讀使用說明書以及附屬的所有說明資料。另外，請您妥善保管本使用說明書，以便隨時可以立即查閱。
- (2) 本注意事項中有部分內容可能不是您所購買的機器規格的內容。
- (3) 為了防止斷針造成的事故，請戴上安全防護眼鏡進行操作。
- (4) 使用心臟起搏器的人，請一定要與專門醫生諮詢之後再使用。

#### 2. 安全裝置、警告標籤

- (1) 為了防止由於沒有安裝安全裝置而造成的事故，操作本機器時，請確認安全裝置是否正確地安裝到規定位置之後再進行操作。
- (2) 為了防止人身事故，卸下了安全裝置後，請一定再安裝到原來的位置，並確認功能是否正常。
- (3) 為了防止人身事故，請把警告標籤時常地粘貼到可以明顯看到的機器上。如果脫落或發生汙損，請立即更換成新的標籤。

#### 3. 用途、改裝

- (1) 為了防止人身事故，請不要將本機器使用於本來的用途和使用說明書規定的使用方法以外的用處。
- (2) 請不要改裝機器。任何未經授權的規範更改都不在保修範圍內。
- (3) 本公司對因改裝或更改的機器造成的損壞，傷害或死亡不承擔任何責任 / 義務。

#### 4. 教育培訓

- (1) 工廠經理 / 主管有義務為操作員和維修技師提供教育和培訓。良好的教育 / 培訓計劃不僅可以避免人身傷害，還可以防止財產損失。
- (2) 只讓具有訓練有素的操作員操作機器。
- (3) 只讓具有經過認證的技術人員為機器提供服務。

#### 5. 必須關閉電源的事項

關閉電源：按 EMG 停止（如果有），是指關閉電源開關之後，並且把電源插頭從電源插座上拔下來。

- (1) 當確認了異常、故障後以及停電時，按 EMG 停止（如果有），請立即關閉電源。
- (2) 為了防止因機器突然啟動造成的事故，在如下情況時，請一定關閉電源之後再進行操作。
- (3) 清潔或檢查機器時，請確保機器在關閉電源後完全停止。
- (4) 執行維修（即更改調整任何組件）時，請確保電源已關閉且機器完全停止。

6. 為了防止觸電、漏電、火災事故，拔電源插頭時，一定要手持插頭拔電線，而不能拉著電線拔。
7. 只要機器在工作之間無人看管，請關閉電源。
8. 如果出現電源故障或停電，請關閉電源以避免損壞或發生事故。
9. 不遵守上述指示可能會對操作員造成嚴重傷害或死亡。

## 在各使用階段的注意事項

### 1. 搬運

- (1) 抬起縫紉機移動時，請一定根據機器的重量採用確保安全的方法進行搬運。另外，有關機器重量，請確認使用說明書的說明。
- (2) 抬起縫紉機移動時，請採取確保安全的措施防止翻倒、掉落。
- (3) 為了防止不可預想的事故、掉落事故、機器損壞，請不要再次包裝已經開箱的機器進行搬運。

### 2. 開箱

- (1) 開箱時請按照從上方開始的順序進行開箱。木框包裝時，請一定要小心不要被釘子紮破。請把釘子從木板上拔下來。
- (2) 取出機器時，請一定首先確認機器的重心位置然後小心地取出。

### 3. 安裝：

#### 3A. 機台、台腳

- (1) 請一定使用純正的機台、台腳。不得以使用非純正的零件時，請一定使用可以充分承受機器重量、運轉時的反作用力的機台、台腳。
- (2) 在台腳上安裝腳輪時，請使用具有充分強度的帶鎖定裝置的腳輪，操作機器時、維修保養、檢查、修理時進行鎖定不要機器晃動。

#### 3B. 電纜、電線

- (1) 電纜和電線必須符合規範和要求，請不要向電纜施加過大的力量。
- (2) 電纜和電線應無彎曲或額外的力。在電纜 / 電線和運動部件之間保留至少 30mm 的自由空間。
- (3) 接線時請不要進行分岔佈線。
- (4) 請一定牢固地固定連接器。另外，拔連接器時，請一定手持連接器拔線。

#### 3C. 接地

- (1) 接地是必要的，請具有電氣專門知識的人安裝電源插頭。
- (2) 檢查並確保在操作前確保地線接地。

#### 3D. 馬達

- (1) 電動機必須符合規範和要求。
- (2) 如果馬達傳動裝置中有皮帶，請一定選用安裝有防止捲入功能的皮帶護罩的離合馬達。

#### 4. 操作前

- (1) 接通電源之前，請一定確認連接器、電纜等確實沒有損傷、脫落、鬆動。
- (2) 請確認皮帶輪的轉動方向是否與箭頭標記一致。
- (3) 請一定鎖定腳輪，帶有調節器時，請調節台腳把腳固定好。
- (4) 保持工作區域遠離障礙物。

#### 5. 操作中

- (1) 操作機器時，請注意不要讓手指、頭髮、衣服靠近皮帶輪、手輪、馬達等轉動部位，也不要將物品放到上面。
- (2) 機器設計為高速運轉。始終將手遠離移動區域。在機器完全停止之前，請勿恢復工作循環。
- (3) 拆卸或重置機器時，請注意不要被機器或部件夾住。
- (4) 為避免突然啟動造成的事故，在對電機或皮帶進行維修時，請確保電源已關閉且機器完全停止。
- (5) 伺服電機在機器停止時靜音。務必關閉電源以避免突然啟動。
- (6) 始終保持電源櫃的風扇和氣道暢通無阻。

#### 6. 加油

- (1) 按照手冊中的說明，請使用純正的機油和純正的潤滑脂向規定部位進行加油和塗抹潤滑脂。
- (2) 如果潤滑劑接觸到您的眼睛或身體，請立即將其清洗乾淨。如有必要，請諮詢醫療護理。
- (3) 為了防止腹瀉、嘔吐，如果誤飲了機油，請立即就醫治療。

#### 7. 維修保養

- (1) 只允許經過認證的工程師 / 技術人員對機器進行維修，包括調整和維修。僅使用原裝零件進行更換。對於因維修或調整不當或使用正品以外的任何部件而導致的任何事故，本公司不承擔任何責任 / 義務。
- (2) 只允許經過認證的技術人員或授權工程師維修或維護電氣系統。
- (3) 當對氣缸等氣動部件進行維修時，首先斷開氣源並完全排出空氣，以避免突然啟動。
- (4) 調整更換後檢查所有螺釘和螺母是否固定好。
- (5) 需要定期清潔。清潔前確保電源已關閉且機器完全停止。
- (6) 如果機器功能不良或異常，請停止操作並關閉電源。請聯繫授權經銷商或我們，以獲得技術服務支持。
- (7) 當保險絲發生故障時，關閉電源，找出故障原因並對其進行解決，然後更換相同規格的新電源。
- (8) 定期檢查並清潔風扇通風道和電纜 / 接線。

#### 8. 工作環境

- (1) 請在沒有高頻電焊機等強噪音源（電磁波）影響的環境下使用縫紉機。
- (2) 電源應處於良好可靠的狀態，額定電壓的波動應小於 10%。
- (3) 始終檢查氣壓和質量。如果電源不可靠，可能需要一些額外的設備。
- (4) 本機設計使用環境溫度 5°C ~35°C，相對濕度 35% ~85%。
- (5) 為保護電子元件和安全原因，當溫度急劇上升導致霜凍時，請斷開電源並等待其完全乾燥。
- (6) 出於安全原因，當發生雷鳴或雷電時，請停止操作並斷開電源。
- (7) 請勿在機器附近使用電視或收音機以免干擾。
- (8) 操作期間應用必要的保護。遵守當地政府制定的適用法規。
- (9) 對於包裝，潤滑劑和產品的處理，請遵守當地管理部門製定的適用法規。

# 目 錄

1 概要說明 .....	1
1.1 概述 .....	1
1.2 功能和指標參數 .....	1
1.3 針跡形狀 .....	2
1.4 標準化 .....	2
1.5 操作方式 .....	2
2 基本操作說明 .....	3
2.1 操作面板說明.....	3
2.2 基本操作 .....	4
2.3 花樣程式的設定方法 .....	5
2.4 試送布模式確認縫紉花樣 .....	10
2.5 切刀動作的切換 .....	13
2.6 布料設定位置的切換方法 .....	14
2.7 穿線模式 .....	14
3 縫製操作說明 .....	15
3.1 自動模式 .....	15
3.2 手動模式 .....	16
3.3 暫停開關 .....	18
3.4 迴圈縫製功能的使用方法 .....	20
4 參數設置模式介面 .....	23
4.1 功能說明 .....	23
4.2 軟體版本查詢 .....	24
4.3 軟體升級 .....	24
4.4 參數設置的方法 .....	25
4.5 參數初始化 .....	31
4.6 系統檢測 .....	32
5 附錄 1 .....	33
5.1 報警信息一覽表 .....	33
5.2 資訊提示一覽表 .....	34
5.3 故障檢修 .....	35
6 附錄 2 .....	36
6.1 操作箱安裝尺寸.....	36
6.2 操作箱安裝尺寸.....	36
6.3 MASC511 控制箱外部連接線纜.....	37
6.4 MASC511 圓頭鎖眼機系統框圖.....	38



# 1 概要說明

## 1.1 概述

MASC511 系列工業縫紉機電腦控制系統，主軸電機採用具有世界先進水準的交流伺服控制技術驅動，具有力矩大、效率高、車速穩定和噪音低等特點。操作面板設計多樣化可滿足不同客戶的配套要求；系統採用德國式結構設計，安裝和維修方便快捷，系統面板操作程序可通過 U 盤快速升級，方便使用者不斷提高產品性能。

## 1.2 功能和指標參數





MASC511 系列數控交流伺服系統的功能及參數詳見表 1。

表 1: 功能及參數對照表

序號	項目	機型	MASC511
1	用途		男裝、女裝、休閒裝、牛仔褲、褲裝
2	縫製速度		1000—2700rpm
3	針跡形狀		無加固縫
			錐形加固縫
			直線加固縫
			圓形加固縫
			菊花眼
4	鎖縫長度		圓眼孔 8-42mm、一字形孔 5-50mm
5	針跡節距		0.5-2.0mm
6	針跡幅寬		1.5mm—5.0mm，機械可調 1.5—4.0mm
7	錐形加固長度		0-20mm
8	壓腳高度		標準 12mm（可以到 16mm）
9	啟動方式		雙腳踏開關或是手動開關
10	送布方式		X/Y/Z 的 3 脈衝馬達間歇送布
11	剪麵線及剪底線驅動方式		電磁閥驅動
12	切錘驅動方式		電磁閥驅動
13	安全裝置		急停開關、機頭翻倒開關及電路故障自動保護功能
14	升級方式		U 盤
15	操作面板支援語言		漢語、英語
16	上軸馬達		小型 AC 伺服馬達 750W 皮帶傳動驅動方式
17	空氣壓力		主調節器：0.5MPa，氣錘壓力調節器：0.4Mpa
18	額定功率		600W
19	使用溫度範圍		0°C~45°C
20	使用濕度範圍		35%~85%（無結露）
21	電源電壓		AC 220V ± 10%；50/60Hz

產品執行標準：QCYXDK0004—2016《工業縫紉機電腦控制系統》。

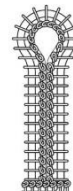
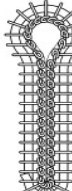
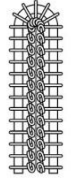
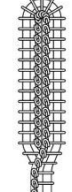
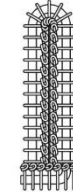
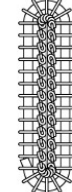
### 1.3 針跡形狀

圓頭鎖眼			
			
無加固縫	錐形加固縫	直線加固縫	圓形加固縫
一字形鎖眼			
			
無加固縫	錐形加固縫	直線加固縫	圓形加固縫
菊花眼			
			

### 1.4 標準化

功能按鍵採用業界公認的圖形標識，圖形是國際化語言，各國使用者都可以識別。

### 1.5 操作方式

採用真彩全觸摸液晶屏，介面更加友好直觀，操作也更為便捷。具體操作方法參考操作說明。

## 2 基本操作說明

### 2.1 操作面板說明

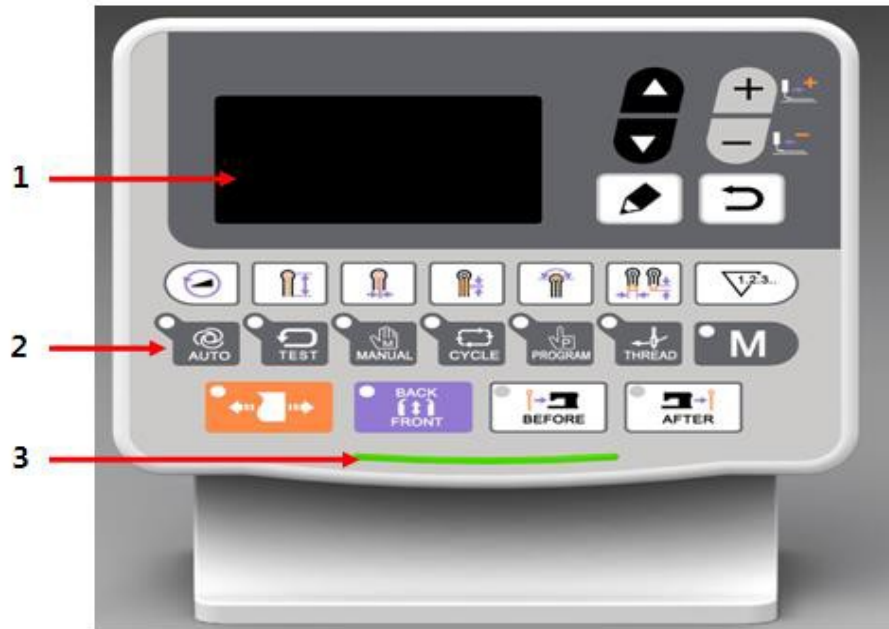

(前面)

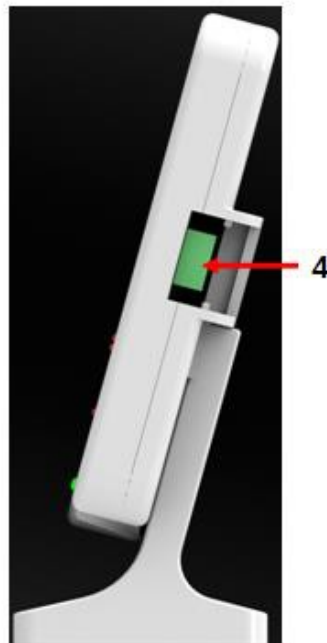

(右側面)

1、花樣資料顯示區域 2、功能模式按鍵區域 3、電源指示燈 4、U 盤插口(右側)

## 2.2 基本操作

### ① 打開電源開關 打開電源開關後，操作螢幕資料

顯示區域依次

顯示：

歡迎使用 MASC511 系列鎖眼機→MASC511-00( 01 或 02 ) →創建資料→請按啟動開關

注：當打開電源之後，操作面板顯示圖 (A) “EB012” 時，請按圖 (B) 所示方向轉動手輪 (1)，使手輪上的鋼印 (2) 和缺口 (3) 一致。



(A)

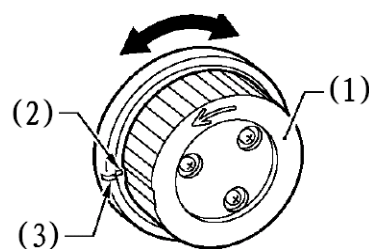

(B)

### ② 按下啟動開關

踩下右側腳踏板開關後，送布台移動到放置布料的位置。操作面板上顯示前一次操作時的模式(自動模式、試送布模式、手動模式、迴圈程式模式、程式模式中的任何一個)的待機狀態。

注：移動到各種模式後，在開始下一個動作前的狀態稱為“待機狀態”。

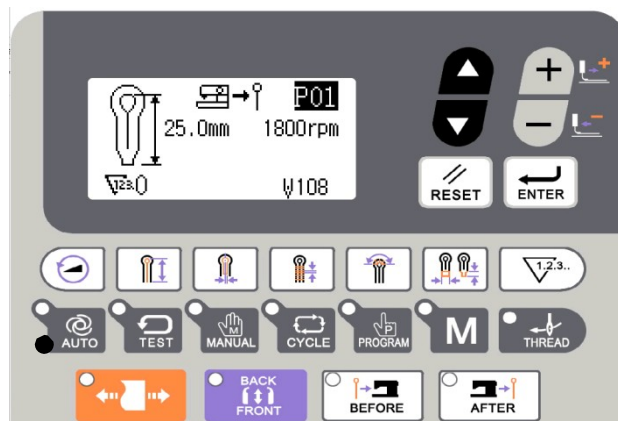

## 2.3 花樣程式的設定方法

2.3.1 縫製資料登錄介面 資料登錄介面如圖所示，詳細功能說明請見

【表 1：按鍵說明表】。

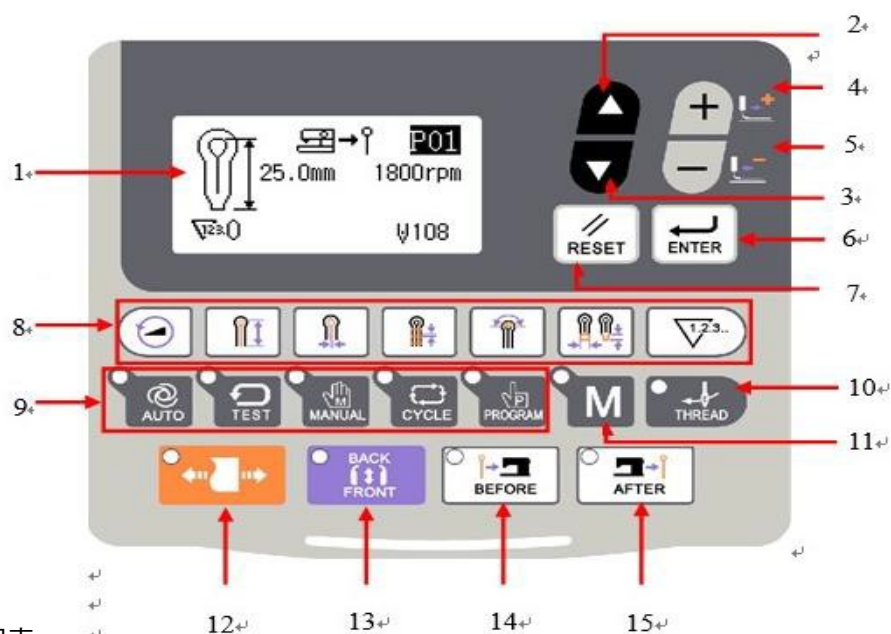

按鍵說明表：

序號	圖示	功能	備註
1		縫製形狀顯示	顯示花樣號，花樣形狀，花樣長度，花樣針數，縫製速度等資訊
2		增加程式及參數號碼鍵	
3		減小程式及參數號碼鍵	
4		增大參數內容及數值鍵	
5		減小參數內容及數值鍵	
6		ENTER ( 確認 ) 鍵	確認參數及花樣資料的內容
7		RESET(復位)鍵	清除錯誤資訊顯示
8		快捷方式鍵	可快捷修改 6 個與花樣相關的參數及快捷設置計數器
9		縫製模式鍵	可切換至自動、手動、試送布、迴圈、程式 5 個縫製模式
10		THREAD ( 穿線 ) 鍵	進入穿線模式時指示燈亮
11		參數管理鍵	進入參數設置

序號	圖示	功能	備註
12		繃布開啟/禁止鍵	設置為開啟時指示燈亮，設置為關閉時指示燈滅
13		前進/後退鍵	將布料放置從“前面”或是“後面”的位置進行交換時使用；設定布料位置為“前面”時指示燈亮，設置布料位置為“後面”時指示燈滅
14		先切刀鍵	設定先切布動作時使用，此時指示燈亮；設置為後切布或者無切布時指示燈滅
15		後切刀鍵	設定後切布動作時使用，此時指示燈亮；設置為前切布或者無切布時指示燈滅

### 2.3.2 花樣程式的設定

提示：建議用戶在使用前，預先設定好經常要使用的花樣資料參數，方便在以後的使用中，只要選擇花樣號碼就能調出已經設定好的花樣。這樣可以節省每次因重新設定花樣參數所需花費的時間。

花樣程式號可以登錄 20 個，並隨時可變更各項目的資料參數。

出廠時，花樣程式號 P01~P20 均保存著預設的花樣程式內容。(程式號 P01~P20 全部是同樣的內容。)

花樣程式設定操作步驟如下：

- ① 按下試送布模式按鍵 
- ② 選擇要更改內容的花樣程序號 P01~P20 (1)。

每按一次  鍵，花樣號(1)就會按 P01→P02→...→P20→C1→C2...C9 的順序切

換(按  鍵則為相反方向切換。)

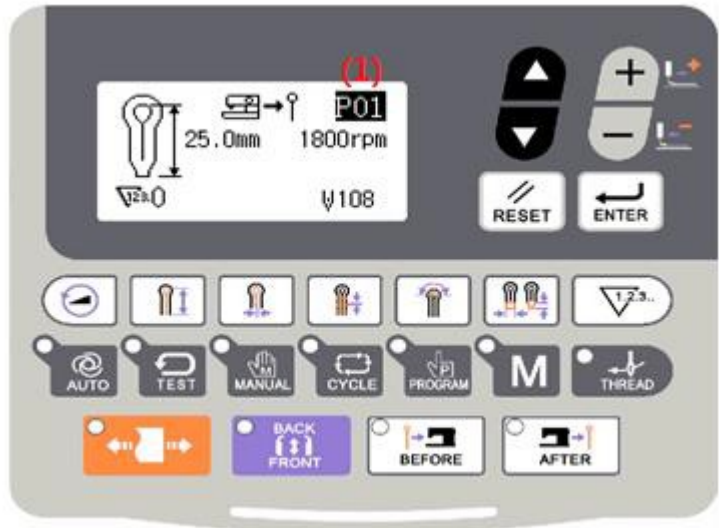



③ 按下程式模式鍵 在花樣資料顯示區域顯示出前次選擇的花樣參數號 (2) 和其具體參數資訊 (3)

④ 按 鍵選擇想要變更的參數號 (2)。

⑤ 按 改變參數 (3) 的內容。參數資訊 (3) 閃爍表示其內容尚未確定。

⑥ 按 鍵確定已更改的內容。參數資訊 (3) 從閃爍變為不閃表示其

內容已被確定。如果在閃爍時不按 鍵，而是按 ，，， 鍵中的任何一種鍵，更改的參數 (3) 會被廢除，恢復為更改前的數值。

⑦ 重複上述的④~⑥步驟的順序，更改其他的參數。

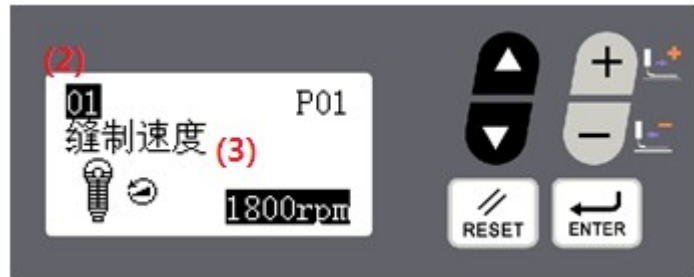

2.3.4

### 2.3.3 關於快捷方式鍵

在快捷方式鍵中，登錄了經常使用的以下 6 個花樣資料修改參數 (S 級參數)。

- (5) 縫紉速度 (參數號 No.01)
- (6) 鈕孔鎖縫長度 (參數號 No.02)
- (7) 切刀間隔 (參數號 No.03)
- (8) 針跡節距 (參數號 No.04)
- (9) 圓頭部針數 (參數號 No.05)
- (10) 加固縫長度 (參數號 No.06、No.08、No.10)



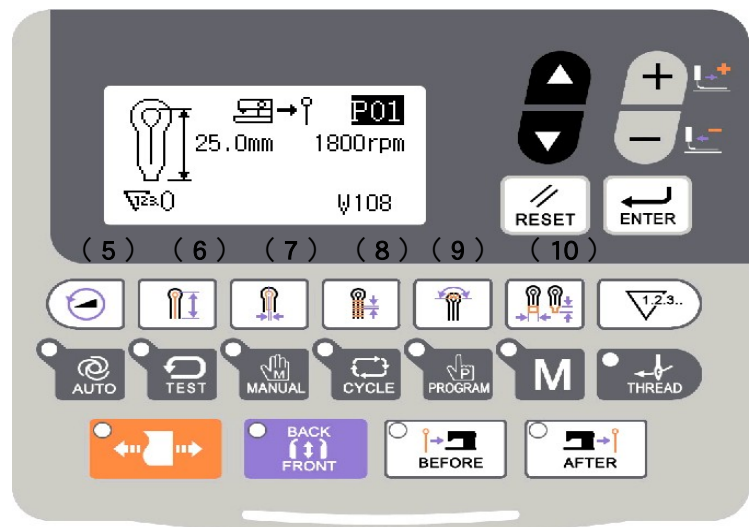















注：在參數號 No.40 中設定不同的加固縫樣式，對應於不同的加固縫長度參數 (10)。



2.3.4 S 級花樣參數一覽表 根據其他參數的設定的內容，有一部分參數的設定值可能無法更改或無效。

參數號	設定內容	設定範圍	單位	初始值
S01	縫製速度 	1000~2700rpm	100	1800rpm
S02	鈕孔鎖縫長度 	5~50mm	0.5	25mm
S03	切刀間隔 	-2.5~0.5mm	0.05	0.2mm
S04	針跡節距 	0.5~2.0mm	0.1	1.0mm
S05	圓頭部針數 	4~20 針	1	9 針
S06	錐形套結長度 	1~20mm	1	6mm
S07	偏移量 	0.5~2.0mm	0.1	1.5mm
S08	直線加固縫長度 	2.0~6.0mm (單側 3.0mm 為止)	0.1	5.0mm
S09	直線加固縫針數 	5~18 針	1	7 針
S10	圓形加固縫針數 	5~17 針	1	7 針
S11	切刀形狀 	1~6 (根據不同的切刀號碼，選擇適當的切刀形狀)	1	2
S12	針擺寬度校正 	-1.0~1.0mm	0.1	0.0mm
S13	圓頭部位低速 	-600~0rpm (圓頭部位低速是以參數 01 縫紉速度的設定值為基準)	100	0rpm
S14	直線加固縫速度 	1000~2500rpm (縫紉速度比直線加固縫速度慢時，直線加固縫速度將和縫紉速度一樣)	100	1800rpm
S15	慢起針針數 	0~3 針	1	0 針
S16	慢起針速度 	400~1500rpm (縫紉速度比慢起針速度慢時，慢起針速度將和縫紉速度一樣)	100	700rpm
S17	切刀 X 方向校正 	-0.5~0.5mm	0.05	0.0mm



參數號	設定內容	設定範圍	單位	初始值
S18	切刀 Y 方向校正 	-0.7~0.7mm	0.05	0.0mm
S19	起縫加固縫針數 	0~4 針	1	0 針
S20	尾縫加固縫針數 	0~4 針	1	0 針
S21	X 方向校正 	-1~6	1	0
S22	Y 方向校正 	-1~6	1	0
S23	$\theta 1$ 校正 	-3~3	1	0
S24	$\theta 2$ 校正 	-3~3	1	0
S25	錐形套結角度 	-5~5	1	0
S26	加固縫寬度校正 	-1.0~0.0mm	0.1	0.0mm
S27	加固縫重合量 	0.0mm~2.0mm	0.1	1.0mm
S28	加固縫 X 方向校正 	-1.0mm~1.0mm	0.1	0.0mm
S29	加固縫傾斜校正 	-3~1	1	0
S30	圓頭部形狀校正	-25~25	1	0
S31	尾縫加固縫節距 	20%~100%	5%	100%
S32	圓形結重疊針數 	1~4 針 (45°以內)	1	1 針
S33	無切刀時的運針 	1~2	1	1
S34	菊花眼切刀尺寸 	2~5mm	1	2
S35	菊花眼針數 	8~100 針	1	20
S36	菊花眼重疊針數 	1~5 針 (45°以內)	1	2
S37	加固縫間距	0~30	1	0
S38	預留 (將來升級擴展時使用。)			
S39	複製花樣	OFF~P01~P20	1	OFF
S40	加固縫樣式 	1 : 無加固縫 2 : 錐形加固縫 3 : 直線加固縫 4 : 圓形加固縫	1	2
S41	雙重縫使能	OFF : 關閉 ON : 打開		OFF
S42	圓頭大小微調	-0.5~0.8	0.1	0
S45	花樣生成方式	0~1	1	1

## 2.4 試送布模式確認縫紉花樣

試送布模式是在主軸停止的狀態下，僅送布台按正常縫紉時的狀態一樣進行工作。使用該模式便於對機針和壓腳之間的位置關係進行確認。

- ① 按下試送布模式鍵 按下試送布模式鍵





後，在縫製數

據顯示區域顯示出

縫紉花樣的針跡形狀 (1)、  
花樣號碼 (2)、  
總針數 (3) 剩  
餘針數 (4)。

- ② 選擇花樣號

每按一次  鍵，花樣號 (2) 就會按 P01→P02→…P20→C1→C2…C9…P01 的順序切換。(按  鍵正好相反，為逆順序。)

- ③ 按下壓腳開關 踩下左側壓腳踏板 (5)

後，壓腳下降

- ④ 按下啟動開關 踩下右側啟動踏板 (6)

後，送布台將  
會移動到縫紉開始的位置處。

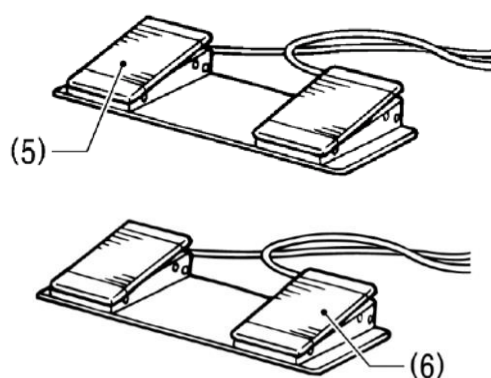
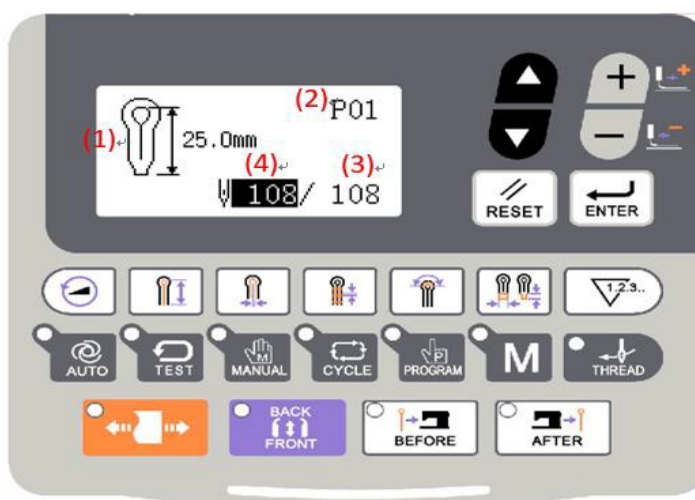

- ⑤ 按啟動開關（右側踏板）(6) 或是按

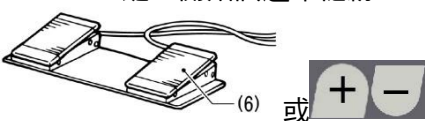
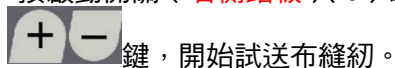

（每按一次縫紉 2 針。）  
（如果一直按著的話就會連續縫紉。）

注：縫紉資料顯示區域顯示的剩餘針數 (4) 每次減少 2 針。

到達最後一針時蜂鳴器會鳴響。試送布模式，不進行剪線和切刀動作。

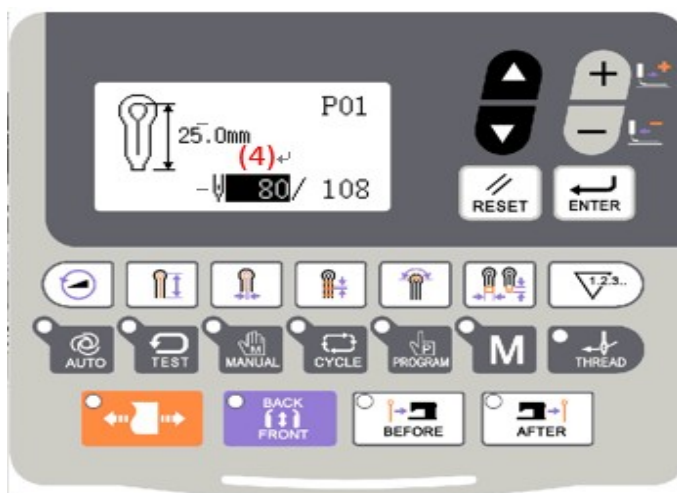

- ⑥ 試送布終止時送布台回到布料設定位置。



按下暫停開關 (7)，然後再按  
鍵

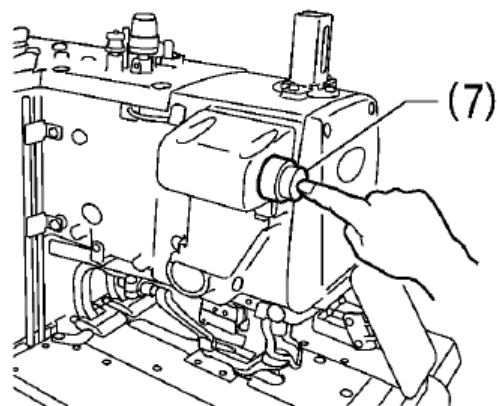

- ⑦ 送布中，想要送布台回到前面的縫紉位置時。

按下  鍵，每按一次會倒退 2 針。縫製資料顯示區域顯示的剩餘針數(4)每次會增加 2 針。

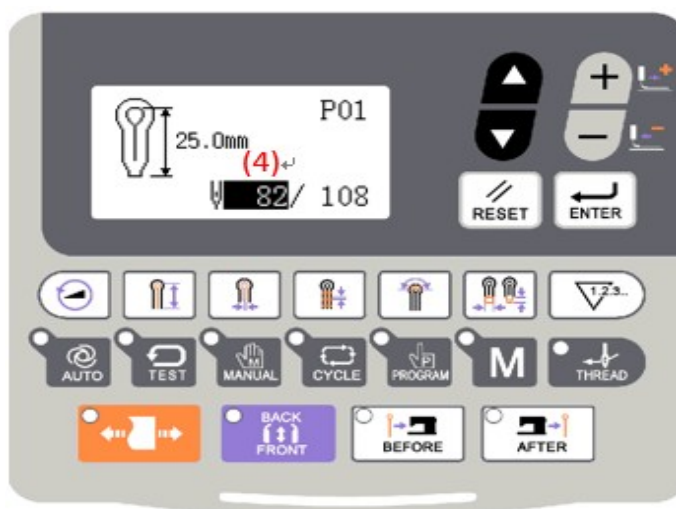

- ⑧ 到達最後一針時。踩下啟動踏板開關 (6)，一直到縫製

資料區域顯示的剩餘針數變為 0，送布台回到布料設定位置為止。之後花樣資料區域會顯示“送布測試結束!”。

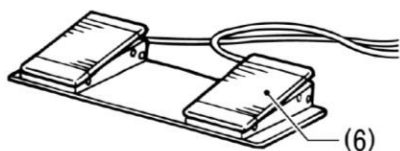

## 2.5 切刀動作的切换

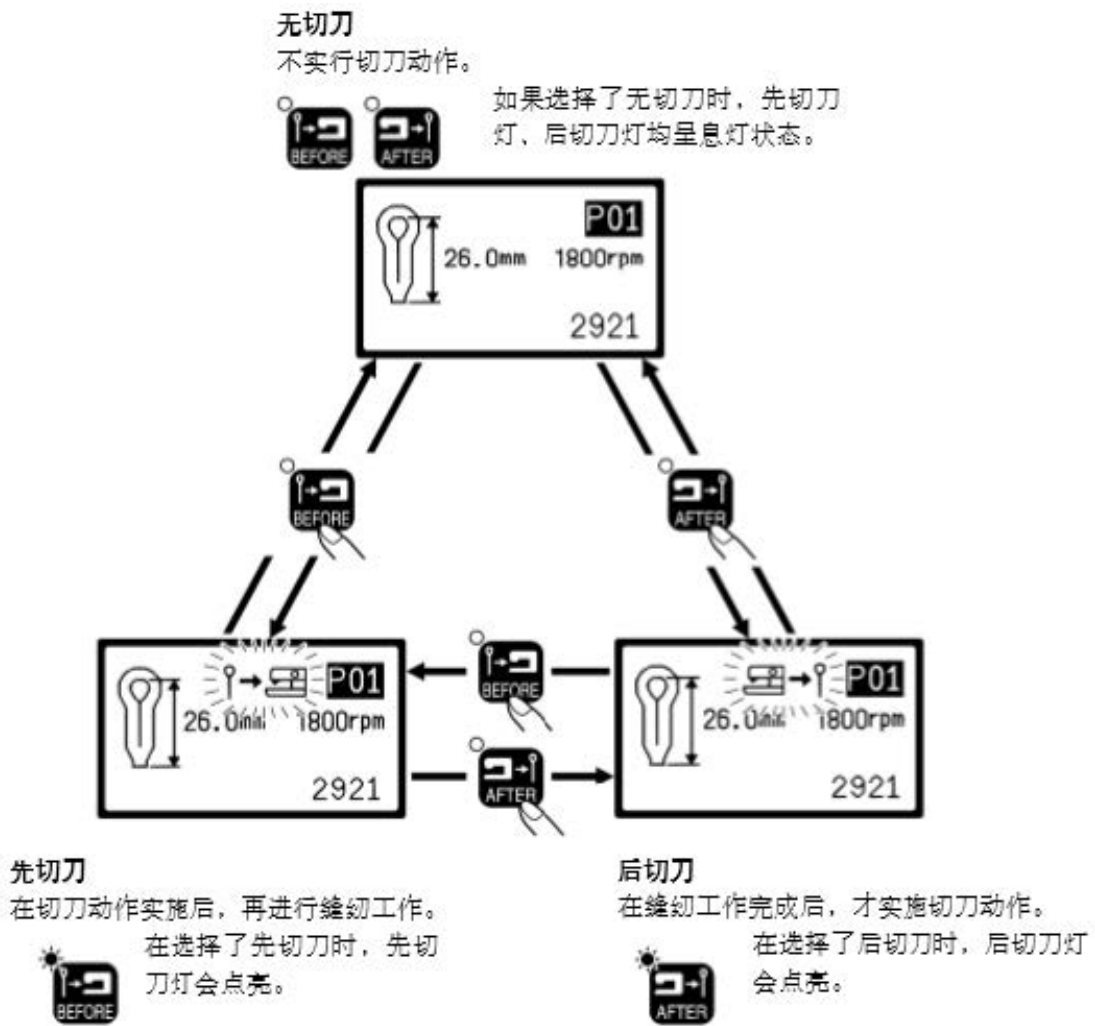

## 2.6 布料設定位置的切換方法

因能將送布台比標準的布料設定位置更向前移動，所以比較容易進行布料的設置。特別是使用後切刀時，迴圈時間被縮短。

【要移動送布台到跟前時】在自動模式、試送布模式或是手動模式的待機狀態時，按 FRONT/BACK 鍵。



【要移動送布台到後面(標準布料設定位置)時】再一次按 FRONT/BACK 鍵



## 2.7 穿線模式

穿線模式在穿麵線時使用。如果切換成穿線模式時，針杆的 Z 軸進行 180° 的轉動後，X、Y、Z 軸步進電機的勵磁將被切斷。此時，針杆和送布台可以自由移動，便於穿麵線。

① 進入穿線模式 在自動模式、試送布模式或是手

動模式的待機、狀態時，按穿線模式按鍵 (1) 將送布模式切換為穿線模式，此時：

1. 花樣資料顯示區域會顯示“請按 RESET 按鍵”(2)。
2. 夾線器變為開放狀態。
3. 蜂鳴器鳴響，針杆回轉 180°，之後 X、Y、Z 軸步進電機的勵磁被切斷。

② 穿麵線 三分鐘後，夾線器自動關閉。

③ 穿麵線完成



穿麵線完成後，按  鍵 針杆和送布台在回原點進行原點檢測後，返回到布料設定位置。夾線器關閉。

## 3 縫製操作說明

### 3.1 自動模式

初次進行自動縫紉時，請務必進行試縫。

在氣溫較低的環境下使用 MASC511 時，請進行多次試縫操作，以便使電機加溫。

- ① 按下自動模式鍵

按下自動模式鍵  後，在花樣資料顯示區域顯示縫紉針跡的形狀及長度

- (1) 花樣形狀
- (2) 花樣號碼
- (3) 切刀動作
- (4) 縫製轉速
- (5) 當前花樣總針數，
- (6) 生產計數器

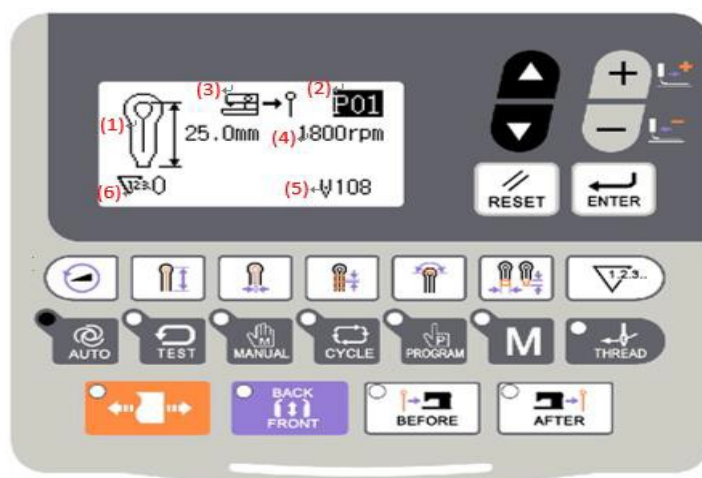

- ② 按  鍵選擇想要的花樣程序號(2)。

每按一次  鍵，花樣程序號(2)就會按 P01→P02→… P20 → C1 → C2 … C9 的順序切換

(按  鍵則為相反方向切換。)

- ③ 選擇希望的切刀動作(無切刀/先切刀/後切刀)。注：有關切刀動作的切換方法具體請參考【】
- ④ 在壓腳下放入要縫製的布料後，踩下壓腳踏板開關(7)。

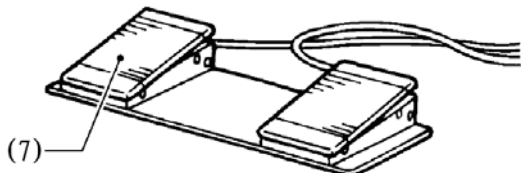

- ⑤ 按啟動踏板開關(8)，縫紉開始。

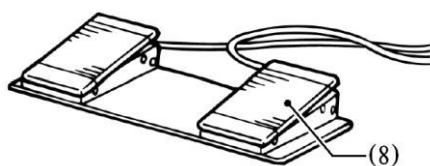

- ⑥ 如果要反復縫製時，請重複操作上述的第④~⑤的步驟

## 3.2 手動模式

### ⚠ 注意



在手動縫紉中因切錘有動作，請不要將手放在切錘旁邊。有可能會導致重傷。

在手動模式下，用手轉動手輪，送布台能一針一針的移動。這對進行分紗器的同步調整時會比較方便。

- ① 按 成手動模式 在縫製資料顯示區域顯示 縫紉針跡的形狀 (1) 花樣程式號碼 (2) 切刀動作 (3) 總針數 (4) 剩餘針數 (5)。

- ② 按 鍵選擇希望的花樣程式號 (2)

每按一次 鍵，花樣程式號 (2) 就會按 P01→P02→…→P20→C1→C2…C9 的順序

切換 (按 鍵則為相反方向切換。)

- ③ 在壓腳的下面放入縫製布料，按下壓腳開關 (6)，放下壓腳

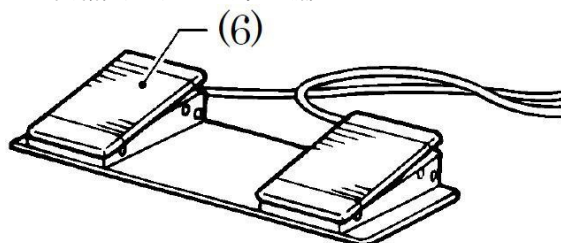

- ④ 按啟動開關 (7)，將送布台移動到縫紉開始的位置。

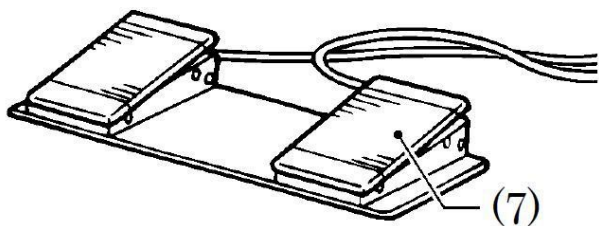

注意：將切刀動作設定為“先切刀”時，因切錘的移動請一定注意安全。

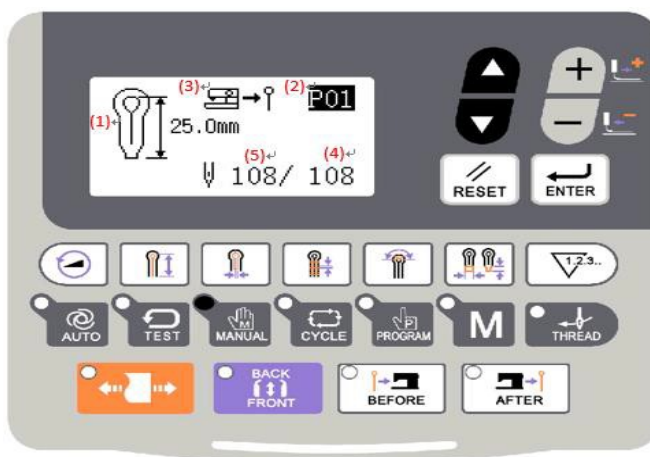



⑤ 上軸手輪向左回轉

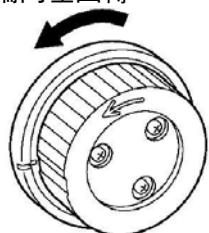

上軸手輪每轉一圈，送布台會移動到下一針的縫紉位置，上軸手輪每回轉半圈（針杆上下 1 次），縫製資料顯示區域顯示的剩餘針數（5）就會減少 1 針。

注意：如上軸手輪逆方向轉動的話，送布台將不會移動形成針跡的形狀，請不要將手輪逆向轉動。

⑥ 如想中止手動縫紉，送布台回到布料放置位置時按急停開關（8）

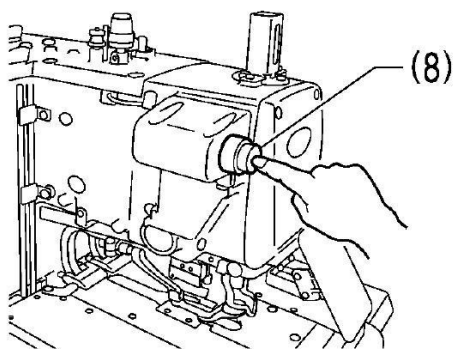

操作面板顯示“縫紉中暫停開關被按下”，按  鍵。

鍵解除報警返回縫製畫面，然後再按

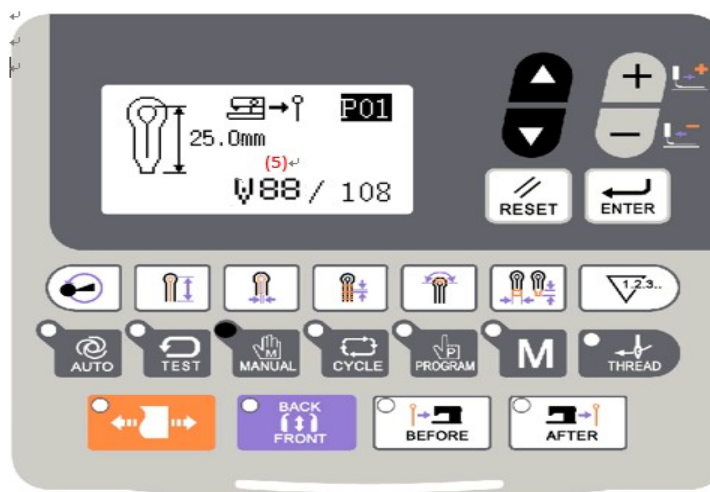

- ⑦ 在到達最後一針時 針杆在針的上位置  
停止狀態，按啟動開  
關(7)。

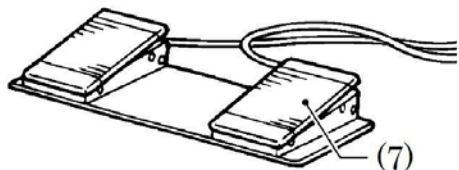

(一直按著，直到送布台回到布料放置  
位置為止。)

在進行切線動作，送布台回到布料放置  
位置之後，操作面板提示“手動操作結束”。

注意：將切刀動作設定為“後切刀”時，  
因切  
錘的動作，請一定要注意安全。



### 3.3 暫停開關

自動縫紉中的暫停 暫停開關一般是在

發生斷線等情況  
時為了讓縫紉機停車而使用。

3.3.1 暫停的方法 在縫紉中，按下暫停開  
關(1)後，

縫紉機將停車，操作面板會提示“在縫紉  
中按下了急停開關”。

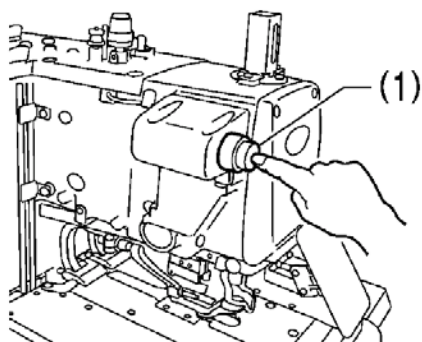

### 3.3.2 解除暫停的方法（不進行繼續縫紉時）

- ① 在操作面板提示“在縫紉中暫停開關被按下”時按復位鍵（2）。

操作面板返回到縫紉畫面，在花樣數據顯示區域顯示“請按 RESET 或“向下”按鍵”。

- ② 排除暫停時的異常原因。

- ③ 按下  復位鍵，針杆和送布台在進行原點檢測後，返回到布料設定位置。



### 3.3.3 解除暫停的方法（進行繼續縫紉時）

- ① 在操作面板提示“在縫紉中暫停開關被按下”時按復位鍵（2）。

操作面板返回到縫紉畫面，在花樣數據顯示區域顯示請按“RESET”返回或“向下”按鍵。



- ② 排除暫停時的異常原因

如果麵線發生斷線等情況時，可以按





鍵進入穿線模式。

- ③ 按一次“向下”按鍵 ，在花樣數據顯示區域會顯示出縫紉花樣的總針數（3）和剩餘針數（4）。

- ④ 按  鍵或  鍵，送布台可以按縫製

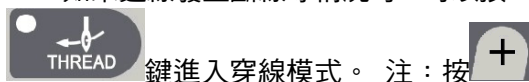
如果麵線發生斷線等情況時，可以按



鍵進入穿線模式。注：按 

鍵前進，按  鍵倒退。

如果一直按著的話將會連續前進或倒退。

- ⑤ 選定好繼續縫紉的位置後，  
踩啟動踏板開關（5），繼續完成當前花樣的自動縫紉。

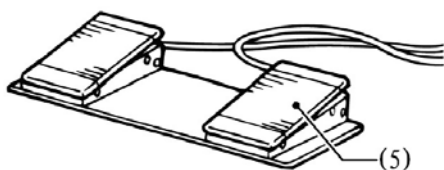

### 3.4 迴圈縫製功能的使用方法

在單獨花樣程式（P01~P20）中，可以對編輯好的單獨花樣進行組合，登記成多個花樣進行連續縫製的“迴圈花樣程式”，便於使用。

迴圈花樣程式：

迴圈花樣最大設定數	9 個（C01~C09）
單個迴圈花樣的最大花樣數	9 個（S1~S9）（同一個單獨 P 花樣程式可以被多次選擇）

程式示例：

選擇 3 步為有切刀動作的單獨花樣程式 P01，和 1 步為無切刀動作的單獨花樣程式 P03 組成迴圈花樣程式，將該程式設定為 C1 作為示例進行說明。

迴圈花樣程式 C1 的設定內容：

C 花樣步號	S1	S2	S3	S4
單獨花樣號	P01	P01	P01	P03
切刀動作	有	有	有	無

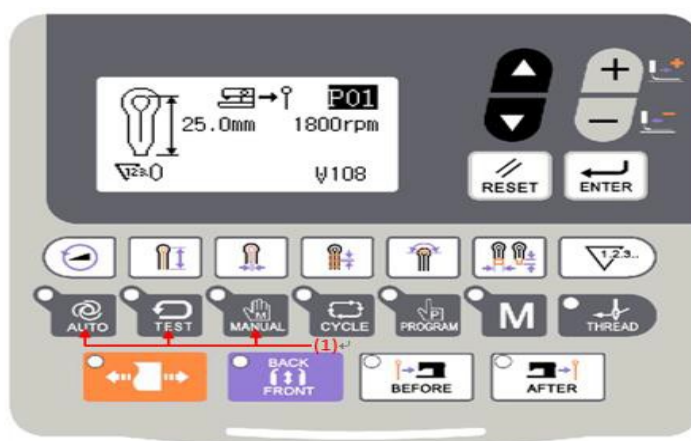

- 按右圖中的按鍵(1)，選擇任意一個縫紉模式。（以自動模式為例）

- ② 按   鍵選擇循環花樣程式號 C1。



每按一次  鍵，花樣號就會按 P01→P02→…P20→C1→C2…C9…P01 的順序

切換。(按  正好相反，為逆順序。)

- ③ 按下迴圈程式模式 (2) 在縫製資料顯示區域會顯示：

步號 (3) 迴圈程式號 (4) 步號 S1 中被設定的

花樣號內容 (5)。

- ④ 按   鍵把步號 S1 的內容 (5) 設定為 P01。“P01”的“\_”是有切刀動作之意，在縫製資料顯示區域會有切刀打開的顯示 (6)。

“P--”的“--”是未設定花樣之意。

如果當前花樣設定了“P--”的話，之後的步號中的內容均會被刪除。

- ⑤ 按  鍵確定已更改的內容。





步號 S1 的內容 (5) 將從閃爍變為不閃爍。

- ⑤ 按   將步號 (3) 變為 S2

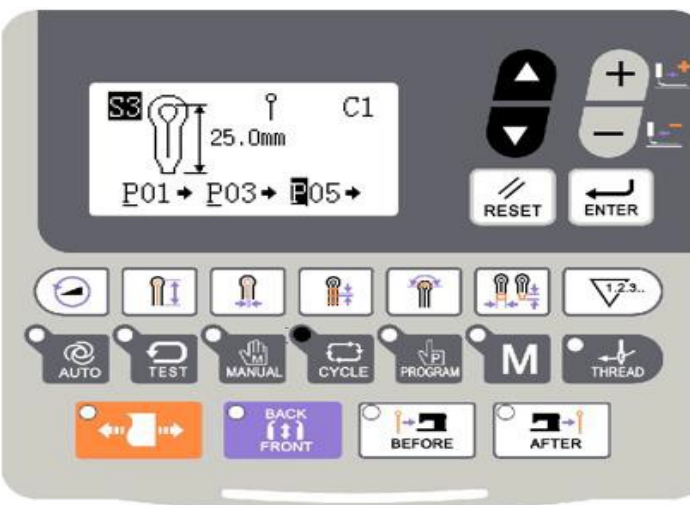
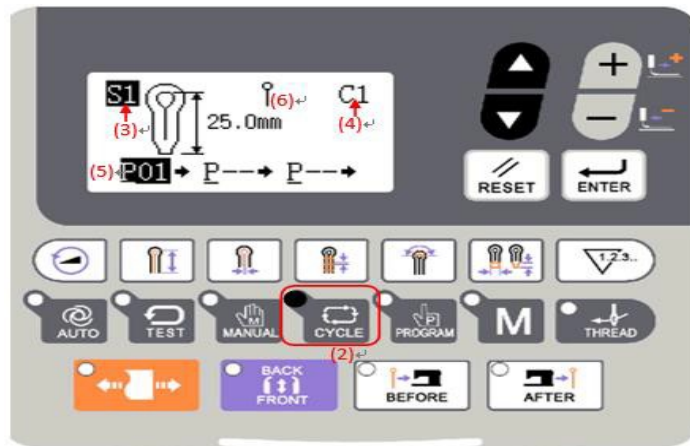
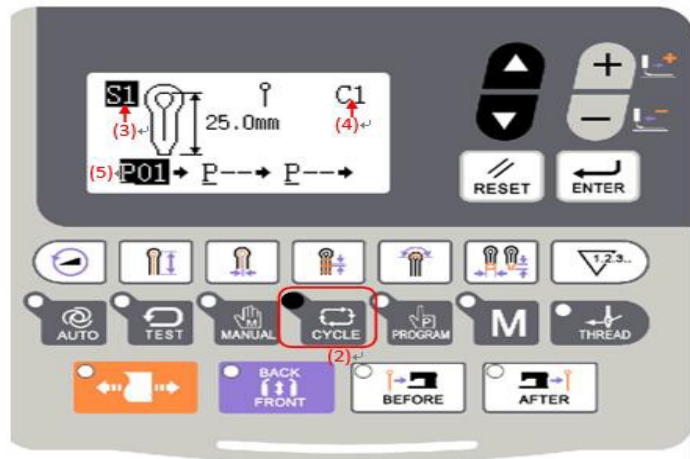
- ⑥ 重複上述的 4~5 的步驟，將步號 S2 的內容設定為和 S1 相同的“P01”，將步號 S3 的內容也設定為和 S1 相同的“P01”。

- ⑦ 按  鍵確定已更改的內容。



- ⑧ 按  或  將步號 (3) 變為 S4。
- 按  或  鍵把步號 S4 的內容 (6) 設定為 P03。
- 按切刀動作鍵 (7) 將 (6) 處的 “P03” 改為 “P03” (無切刀動作的設定)

- ⑨ 按  鍵確定已更改的內容。

按 (1) 中的任意一個鍵，結束迴圈程式模式的設置。

注：選擇了迴圈程式進行自動縫製時，對於切刀動作來說，在自動縫製模式時依然可以進行切刀動作的更改，C 花樣程式中有切刀動作的花樣將以當前的切刀模式設定一致。

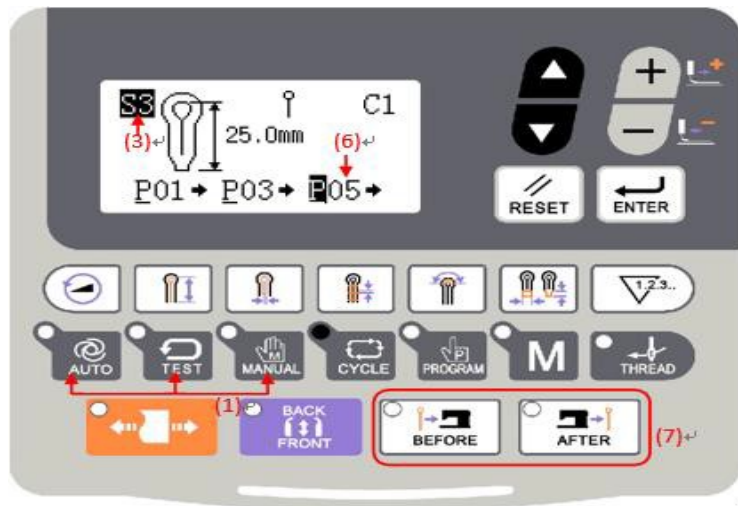

## 4 參數設置模式介面

在縫製資料登錄介面，按下

**M** 鍵可以切換資料輸入介面和參數設置模式介面（如右圖所示），在參數模式介面下可以進行一些詳細的設置和編輯操作。在該

介面模式下按 **AUTO**、**TEST** 或

**MANUAL** 鍵均可退出參數設置模式，回到自動縫製、試縫模式或手動模式。



設置模式

### 4.1 功能說明

進入參數設置模式後，可以按 **▲** 或 **▼** 鍵選擇需要設置的功能選項，然後按 **▶** 鍵，可選的功能包括：

序號	功能
1	參數設置
2	參數初始化(恢復出廠設置)
3	軟體版本查詢
4	軟體升級
5	系統檢測

## 4.2 軟體版本查詢

在設置模式，按下▲或▼鍵，直到選項顯示為“軟體版本”，按ENTER鍵進入軟體版本查詢介面（如右圖所示）。在該介面下按▲或▼鍵能分別查看主控、面板、步進的程式版本。按M鍵退出該功能模式。

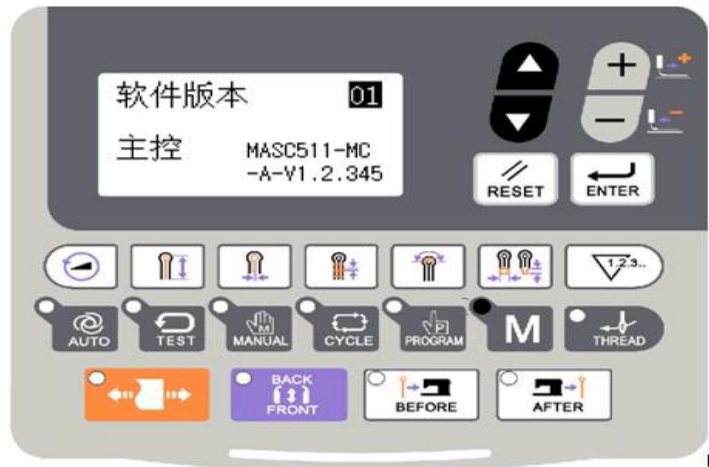

## 4.3 軟體升級

此操作頭支援 U 盤升級。

### （1）升級主控

第 1 步：首先在 U 盤根目錄下建立一個“update”為檔案名的資料夾。把主控程式“mControl”放在“update”檔加下。

第 2 步：之後把 U 盤插到操作頭上，

按下M鍵進入參數功能設置模式，在設置模式下，按下▲或▼鍵，直到選項顯示為“軟體升級”，按ENTER鍵進入。

第 3 步：按下ENTER鍵，升級即可。面板顯示升級完成後，將機器關閉電源後再開電，重啟機器。即完成升級操作。

注意：在升級過程中不要斷電，直到系統提示升級已完成提示重新啟動系





統才可斷電重啟系統。

## (2) 升級面板

第 1 步：首先在 U 盤根目錄下建立一個“update”為檔案名的資料夾。把面板程序“LCDpanel”放在“update”資料夾下。

第 2 步：在縫紉機開機上電前，先插入含有升級面板程式的 U 盤，之後同時按住操作面板三個鍵：





開機啟動。操作頭顯示直接進入升級面板模式。



第 3 步：然後按  鍵系統會自動進入升級狀態。面板顯示升級完成後，將機器關閉電源後再開電，重啟機器。即完成升級操作。

注意：在升級過程中不要斷電，直到系統提示升級已完成提示重新開機系統才可斷電重啟系統。

## 4.4 參數設置的方法

在設置模式下，按  或  鍵選擇“參數設置”選項，然後按  進入 U 級參數設置界面（如右圖所示）。

按  鍵退出參數設置介面。按  或  鍵選擇想要修改的參數，按  或  鍵修改參數的值，按  確認修改。注意按了  或  鍵後表示參數正在被修改，此時該參數的數值底色變白；按  鍵確認後，參數設置完成，該參數的參數值底色變黑。





參數處於設置狀態



參數設置確認後

#### U 級參數表

序號	功能項	設置方法	設定範圍	編輯單位	出廠設置
U001	1 踏板/2 踏板切換	0:模擬單踏板 1:按下啟動開關後，壓腳下降，縫紉機啟動 2：先按下壓腳開關，壓腳下降，然後再按啟動開關，縫紉機啟動	0~2	1	2
U051	1 踏板先切刀時的延遲時間	在先切刀的自動縫紉時，1 踏板踩下後到氣錘工作時的延遲時間	0~800	50ms	0
U056	送布台前位作業時壓腳下降	0：OFF 在縫紉後，送布台移動到前面的設置位置時，在壓腳抬起的狀態下繼續移動；在找原點時壓腳不下降 1：ON 在縫紉後，送布台移動到 放布位置時才抬起壓腳；在 找原點過程中，各軸回到原點的同時，壓腳下降，直到繡框移動到放布位置 才抬起	0~1	1	0
U057	在試送布中壓腳動作的許可	0：OFF 在試送布中禁止壓腳的上升 1：ON 在試送布中進行下列操作	0~1	1	0

序號	功能項	設置方法	設定範圍	編輯單位	出廠設置
		時壓腳可以上升： (A)：手動開關或者是 2 連腳踏板開關時：按下壓腳開關 (B)：腳踏板時：返回踏板 試送布再開時，必須進行下列操作壓腳下降 (A)：手動開關或者是 2 連腳踏板開關時：按下壓腳開關 (B)腳踏板時：返回踏板			
U058	自動縫紉完了後的壓腳動作	0：UP 自動縫紉完了後，壓腳上升 1：DOWN 自動縫紉完了後壓腳保持著下降的狀態上升壓腳時，請進行下列操作： (A)：手動開關或者是 2 連腳踏板開關時：按下壓腳開關 (B)：腳踏板時：返回踏板	0~1	1	0
U150	暫停時的針上位置停止	OFF：在暫停時，上軸被緊急停止 ON：在暫停時，上軸被針上位置停止	0~1	1	1
U152	上軸收針速度	最終一針的速度可以設定	700~900	10rpm	800
U153	上軸停車速度	停車的速度可以設定	250~450	10rpm	350
U156	上軸停止距離	如數值加大時停車控制區間會變長	2.5~17.5	0.5°	11.0
U256	原點位置檢出週期	0：OFF 縫紉完了後，不進行原點位置檢出 1~9：每完成設定的縫紉次數後進行原點位置檢測	0~9	1	0
U301	自動模式的參數確認欄	1：表示縫紉長度 2：表示節距	1~2	1	1
U303	液晶屏對比度	用於調整液晶屏的對比度	0~30	1	15
U350	程式模式的禁止	0：OFF 一般情況 1：ON 禁止進入程式模式，快捷鍵也變成無效	0~1	1	0
U351	迴圈程式模式的禁止	0：OFF 一般情況 1：ON 禁止進入迴圈程式模式	0~1	1	0
U352	計數器變更的禁止	0：OFF 一般情況	0~1	1	0

序號	功能項	設置方法	設定範圍	編輯單位	出廠設置
		1：ON 禁止變更產品計數			
U353	縫製速度編輯的禁止	0：OFF 一般情況 1：ON 禁止變更縫製速度	0~1	1	0
U354	程式號碼編輯的禁止	0：OFF 一般情況 1：ON 禁止變更程式號碼，但是 能夠變更迴圈程式的步號	0~1	1	0
U355	先切刀變更的禁止	0：OFF 一般情況 1：ON 禁止變更先切刀動作（如 禁止前的狀態是先切刀的 情況時，自動變成無切刀）	0~1	1	0
U356	後切刀變更的禁止	0：OFF 一般情況 1：ON 禁止變更先切刀動作（如 禁止前的狀態是後切刀的 情況時，自動變成無切刀）	0~1	1	0
U357	安全開關使能	0：OFF 安全開關無效 1：ON 安全開關有效	0~1	1	1
U358	氣壓檢測使能	0：關閉氣壓監測 1：開啟氣壓監測	0~1	1	0
U450	最高縫製速度	能夠限制最高縫製速度	1000~2700	100rpm	2700
U451	最大循環程式數	能夠設定有效的迴圈程式數（如果不使用迴圈程式數時，可設定為 0）	0~9	1	9
U452	迴圈程式時的產品計數	0：OFF 每縫紉完一個孔後進行產品計數 1：ON 每縫紉完 1 個迴圈後進行產品計數	0~1	1	0
U453	最大切刀間距	設定最大的切刀間距	0.5~1.0	0.1mm	0.5
U454	最大直線加固縫長度	設定最大直線加固縫的長度	6~9	3	6
U455	無切刀時的追加針擺振幅	如果使用無切刀縫紉時，自動的加算設定了的針擺振幅的數值	0~1.0	0.1mm	0
U456	縫紉開始針擺幅度修正	設定縫紉開始時針擺的幅度修正	-1.0~0.0	0.1mm	0
U550	氣錘 ON 時間	數值加大時氣錘和切刀的接觸時間變長	25~200	5ms	25
U551	識別氣錘原點高度	在待機狀態下氣錘位置感應器的讀取值比該值更小時會變成錯誤號碼( E650 )（有氣錘原點錯誤檢查時	150~170	1	160

序號	功能項	設置方法	設定範圍	編輯單位	出廠設置
		才有效)			
U552	氣錘原點錯誤檢查	0 : OFF 無氣錘原點錯誤檢查 (在氣錘位置感應器出故障時使用) 1 : ON 有氣錘原點錯誤檢查	0~1	1	1
U553	根據時間來識別氣錘上升位置	0 : OFF 根據氣錘位置來識別氣錘已下降 50~500 : 根據時間來識別氣錘已下降, (在氣錘位置感應器出故障時使用)	0~500	10	0
U554	根據時間來識別氣錘下降	0 : OFF 根據氣錘位置來識別氣錘以下降 50~500 : 根據時間來識別氣錘已下降, (在氣錘位置感應器出故障時使用)	0~500	10	0
U555	麵線殘留量的增加	0 : OFF 一般情況 1~3 : 由於只設定了的麵線切線的時序延遲, 所以縫紉完了的麵線殘留量也可以比一般情況時有所增加	0~12	1mm	0
U556	麵線松線時間	數值加大時麵線切線後的麵線松線時間會延長	0~100	2ms	50
U557	麵線松線 OFF 時序	0~100 : 如數值加大時麵線切線後的麵線松線 OFF 時間會變遲	0~100	2ms	50
U558	底線剪刀裝置的使用禁止	0 : OFF 一般情況 (底線剪刀裝置工作) 1 : ON 禁止使用底線剪刀裝置	0~1	1	1
U559	忽視底線剪刀感應器和計數器	0 : OFF 根據底線剪刀 OFF 感應器來識別底線剪刀裝置已 OFF 5~50 : 根據時間來識別底線剪刀裝置已 OFF,	0~50	5ms	0
U560	底線剪線時間	0~100 : 如數值加大時底線剪線時間會變遲	0~100	1	0
U561	麵線斷線感應裝置	0 : OFF 麵線斷線檢測裝置無效 1 : ON 麵線斷線檢測裝置有效	0~1	1	0
U562	麵線斷線感應開始針數	1~9 : 被設定的針數縫紉後開始麵線斷線檢測	1~9	1	5
U563	麵線斷線判斷針數	2~7 : 被設定好的針數在連續斷線信號 ON 時, 變成	2~7	1	4

序號	功能項	設置方法	設定範圍	編輯單位	出廠設置
		麵線斷線錯誤			
U564	麵線夾線裝置	0 : OFF 麵線夾線裝置無效 1 : ON 麵線夾線裝置有效	0~1	1	0
U565	麵線夾線 閉合時間的校正	-10~10 : 如數值加大是面線夾線時間會變遲	-10~10	1	0
U576	麵線夾持打開時間	5~20ms : 以 1ms 為單位可設定	5~20	1	10
U577	動框方式	0~5 : 可以選擇不同的動框方式	0~5	1	1
U578	動框同步調整 1	-50~50 : 調整 XY 的動框角度	-50~100	1	0
U579	Z 軸同步調整	-50~50 : 調整 Z 軸的動框角度	-50~50	1	0
U580	麵線挑線動作時間	0~200 : 麵線挑線開始動作時間調整	0~200	5	0
U581	麵線張力調整	0~250 : 調整麵線電磁鐵電流大小	0~250	5	230
U651	錯誤時馬達勵磁狀態	0 : OFF 不可能修復的故障發生時，關閉脈衝馬達的勵磁 1 : ON 不可能修復的故障發生	0~1	1	0
U752	切刀 X 位置校正	設定值是作為切刀 X 位置校正被加算到全部花樣程序	-0.50~0.50	0.05mm	0
U850	縫紉機頭部規格	0 : -00 設定-00 規格 1 : -01 設定-01 規格 2 : -02 設定-02 規格	0~2	1	0
U851	壓腳規格變更(僅 02 款機型才顯示)	0 : L1422 1 : L1826 2 : L2230 3 : L2634 4 : L3442			
U852	菊花眼壓腳	0 : OFF 使用一般(除菊花眼)的壓腳 1 : ON 使用菊花眼壓腳程式時，被表示的是菊花眼專用的參數	0~1	1	0
U853	使用語言	0 : ZH 中文 1 : EN 英文	0~1	1	0
U854	背光自動關閉	0 : OFF 不自動關閉 1 : ON 自動關閉	0~1	1	0
U855	背光自動關閉等待時	設置背光自動關閉等待時	1~9	1 分鐘	3

序號	功能項	設置方法	設定範圍	編輯單位	出廠設置
	間	間			
U856	狀態按鍵顯示風格	0 : Sty1 風格 1 1 : Sty2 風格 2	0~1	1	0
U857	音量大小	30~63 : 調節音量大小	30~63	1	50
U911	切刀定位補償	設定值為切刀感測器的定位補償值	0~60	1	15
U912	主軸電機類型	0 : 360 線電機 1 : 256 線電機	0~1	1	0
U913	DIP1	臨時調整用參數 ( 備用 )	-100~100	1	0
U913	DIP2	臨時調整用參數 ( 備用 )	-100~100	1	0

#### 4.5 參數初始化

在設置模式下，按  或  鍵選擇“參數初始化”選項，然後按  進入 U 級參數設置介面。

按  鍵退出參數設置介面。

進入該模式後，可以選擇：

- ( 1 ) LEVEL1 : 花樣和迴圈程式 ( 包括 S 級花樣參數及 C 花樣迴圈程式 )
- ( 2 ) LEVEL2 : 存儲開關 ( 包括 U 級參數 )
- ( 3 ) LEVEL3 : 全部內部資料

具體初始化內容見下表：

初始化的級別及初始化的內容			
	LEVEL1	LEVEL2	LEVEL3
程式內容	初始值	—	初始值
迴圈程式	清除	—	清除
存儲開關	—	初始值	初始值
程式號	1	—	1
參數號碼	1	—	1
生產計數器	—	—	0
模式	程式	—	程式
布料放置位置	裡面放置	—	裡面放置
切刀動作	OFF	—	OFF



① 選擇要初始化的參數後，按  鍵確認。

畫面切換到如右圖所示，按  鍵後執行初

始化操作，按  鍵將取消初始化操作。



#### 4.6 系統檢測

系統檢測主要用於機械及電控調試。在設置模式下，按  或  鍵選擇“系

統檢測”選項，然後按  進入 U 級參數設置介面。

按  鍵退出系統檢測介面。進入該模式

後，按  或  鍵可以選

擇：

- (1)、輸入檢測，主要用於檢測各傳感開關信號是否正常；
- (2)、輸出檢測，主要用於檢測各電機、氣閥等控制是否正常；
- (3)、轉速檢測，主要用於檢測主軸電機工作是否正常；
- (4)、老化模式，主要用於老化跑合機器；
- (5)、主軸校正，用於主軸角度的校正。

按  鍵可以進入當前選擇的選項。

按  鍵退出當前檢測項介面。





## 5 附錄 1

### 5.1 報警信息一覽表

故障號	故障名稱	復位方法
系統故障		
E-001	IPM 過壓或過流	關機
E-002	電壓 ( 90V ) 過壓	關機
E-003	輔助設備電壓 ( 24V ) 欠壓	關機
E-004	EEPROM 故障	關機
E-005	電機運行異常	關機
特殊故障		
E-006	在待機中按了暫停開關	鬆開暫停開關
E-007	在縫紉中按了暫停開關	按下復位鍵
E-008	暫停開關接觸不良	關機，檢查急停開關是否正常插接，接線是否正確
E-009	接通電源後，一直按著啟動開關或是啟動開關接觸不良	鬆開啟動開關或關機檢測啟動開關是否接觸不良
E-010	一直按著壓腳開關或是壓腳開	鬆開壓腳開關或關機檢測壓腳開關是否接觸不良
E-011	機頭向後傾斜	關機
E-012	針上位置停止錯誤	轉動手輪至針上位置
E-013	同步信號檢出器連接不良	關機，主軸伺服電機編碼器未連接
E-014	X 送布馬達的原點不能檢出，X 送布馬達異常或者是 X 原點感應器連接不良	關機
E-015	Y 送布馬達的原點不能檢出，Y 送布馬達異常或者是 Y 原點感應器連接不良	關機
E-016	$\theta$ 送布馬達的原點不能檢出， $\theta$ 送布馬達異常或者是 $\theta$ 原點感	關機
E-017	IPM 過流	關機
E-018	IPM 頻繁過流	關機
E-019	檢出了主控制程式、馬達之間的程式版本錯誤	關機，需要升級主控或步進驅動程式
E-020	麵線斷線	按下復位鍵
E-021	底線剪線裝置不工作或是底線	關機
E-022	氣錘下降了或是氣錘位置感應	關機
E-023	氣錘不下降或是氣錘位置感應	關機
E-024	電源電壓過壓	關機，檢查輸入的電源是否正常、是否穩定
E-026	電源電壓欠壓	關機，檢查輸入的電源是否正常、是否穩定
E-027	步進電機過流	關機

故障號	故障名稱	復位方法
E-028	冷卻風扇不工作	關機，檢查電控箱內風扇運轉是否正常
E-029	氣錘不能下降到底	關機，增大切刀氣壓
E-030	步進板通信異常	關機
E-031	X 電機運行異常	關機
E-032	Y 電機運行異常	關機
E-033	放布板越界	關機，檢查設置的花樣長度是否在壓腳範圍內
E-034	Z 電機運行異常	關機
E-035	電機閉環異常	關機，主軸伺服電機未在規定時間內回到正常位置，檢查主軸機械上是否有卡點，主軸電機是否正常
E-036	主軸零位元信號異常	關機
E-037	主軸編碼器異常	關機
E-038	主軸停止異常	關機
E-039	縫紉停止異常	關機
E-040	SPI 通信繁忙	關機
E-041	內外針信號錯誤	關機
E-045	花樣針數錯誤	關機
E-046	主軸速度異常	關機
E-050	氣壓不足	關機
E-051	X 電機過流	關機，檢查 X 電機是否正常，檢查電控箱是否正常
E-052	Y 電機過流	關機，檢查 Y 電機是否正常，檢查電控箱是否正常
E-053	X 電機超差	關機，檢查 X 方向是否有卡點，造成機械卡住
E-054	Y 電機超差	關機，檢查 Y 方向是否有卡點，造成機械卡住
E-055	X 電機超速	關機
E-056	Y 電機超速	關機
E-057	MD1 通信異常	關機
E-058	Z 電機過流	關機，檢查 Z 電機是否正常，檢查電控箱是否正常
E-060	Z 電機超差	關機，檢查 Z 軸、彎針座是否有卡點，造成機械卡住
E-062	Z 電機超速	關機
E-064	MD2 通信異常	關機

## 5.2 資訊提示一覽表

信息號	資訊名稱	子資訊內容
M-001	系統參數異常	
M-002	面板資料存儲異常	
M-003	面板與主控通信異常	
M-004	創建資料異常	數據已滿

信息號	資訊名稱	子資訊內容
M-005	創建資料異常	計算錯誤
M-006	資料傳輸錯誤	
M-007	機頭參數異常	
M-008	計數器異常	
M-009	計數器用盡	請復位
M-010	機型不符	
M-011	廠家不符	
M-012	參數導入匯出失敗	

### 5.3 故障檢修

現象	原因	措施
斷線	線張力太大	適當的調整線張力
	機針的安裝方法不正確	按正確的方向安裝機針
	和機針相比線太粗	選擇使用符合機針的線
	機針和彎針的關係不匹配	調整機針和彎針的間隙、針杆高度、彎針和分紗器的高度
	機針、彎針、分紗器、轉線盤和線道有損傷或毛刺	對各零部件進行打磨或更換
	穿線不正確	線上道上正確穿線
跳針	麵線張力太大或太小	適當的調整麵線張力
	機針尖折斷或彎曲	更換新機針
	機針與彎針尖之間的間隙不正確	正確調整機針和彎針尖之間的間隙
	機針、彎針和分紗器的關係不匹配	正確的調整三者之間的關係
	機針和機針護架調整不正確	正確的調整機針護架
	彎針尖變鈍	用油石修理或更換新的彎針
	機針的安裝方法不正確	按正確的方向安裝機針
	機針過細	選擇符合縫製條件的機針
斷、折針	機針彎曲	更換新機針
	機針、彎針和分紗器的關係不匹配	正確的調整三者之間的關係
	機針和機針護架調整不正確	正確的調整機針護架
	機針過細	選擇符合縫製條件的機針
麵線未切斷	上動刀的刀鋒不利	更換新的上動刀
	氣壓太小，上動刀不能切到底	調整氣壓
	上動刀勾不住麵線	安裝麵線彎針在最後前一針處切斷
	最後一針因跳針上動刀勾不住麵線	參考“跳針”一欄，防止跳針
	上動刀的位置不正確	調整上動刀位置
底線未切斷	動刀的刀鋒不利	更換新的動刀
	氣壓太小，上動刀不能切到底	調整氣壓
	動刀的位置不正確	調整動刀、掃線器的位置
	剪底線用的刀壓太小	調整到適當的刀壓
縫紉開始時缺針	底線夾不住	調整底線夾線(01 規格)、或是底線壓板(02 規格)
	麵線在剪線後殘留長度太短	調整副夾線器
	麵線放出量不足	調整麵線放出量
切孔不良	切錘壓力過小	調整到適當的切錘壓力

	切刀和切錘接觸不良	修磨切錘面
	切刀的刀鋒不利	更換新的切刀
線不夠緊密	麵線張力過強或過弱	適當地調整麵線張力
	底線張力過強或過弱	適當地調整底線張力
	挑線簧的強度和行程不合適	調整挑線簧的強度和行程

## 6 附錄 2

### 6.1 操作箱安裝尺寸



圖 4 操作箱安裝尺寸圖

### 6.2 操作箱安裝尺寸

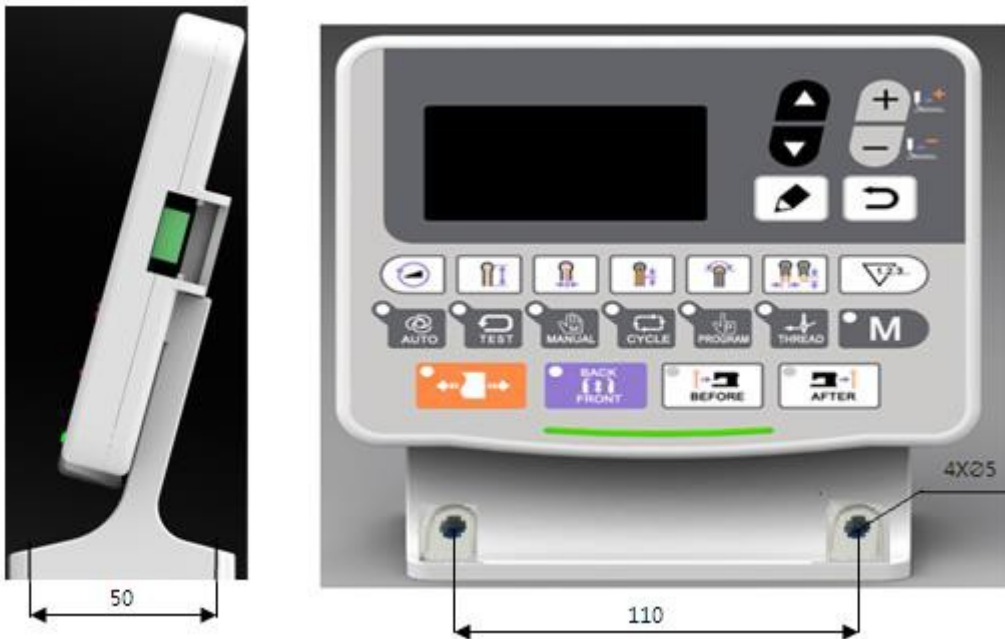
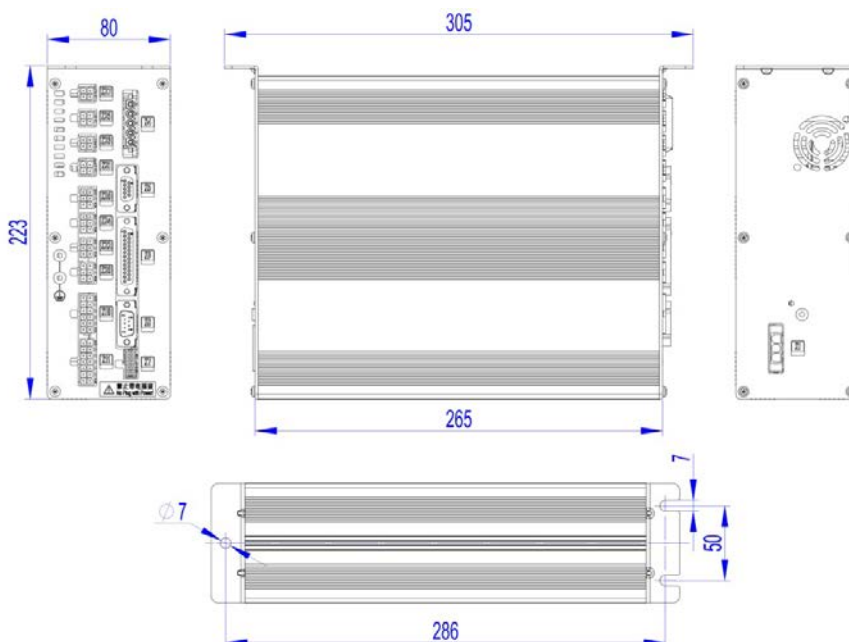

## 6.3 MASC511 控制箱外部连接线缆

外部线缆插头上有对应的编号，请仔细对照图中编号进行连接。

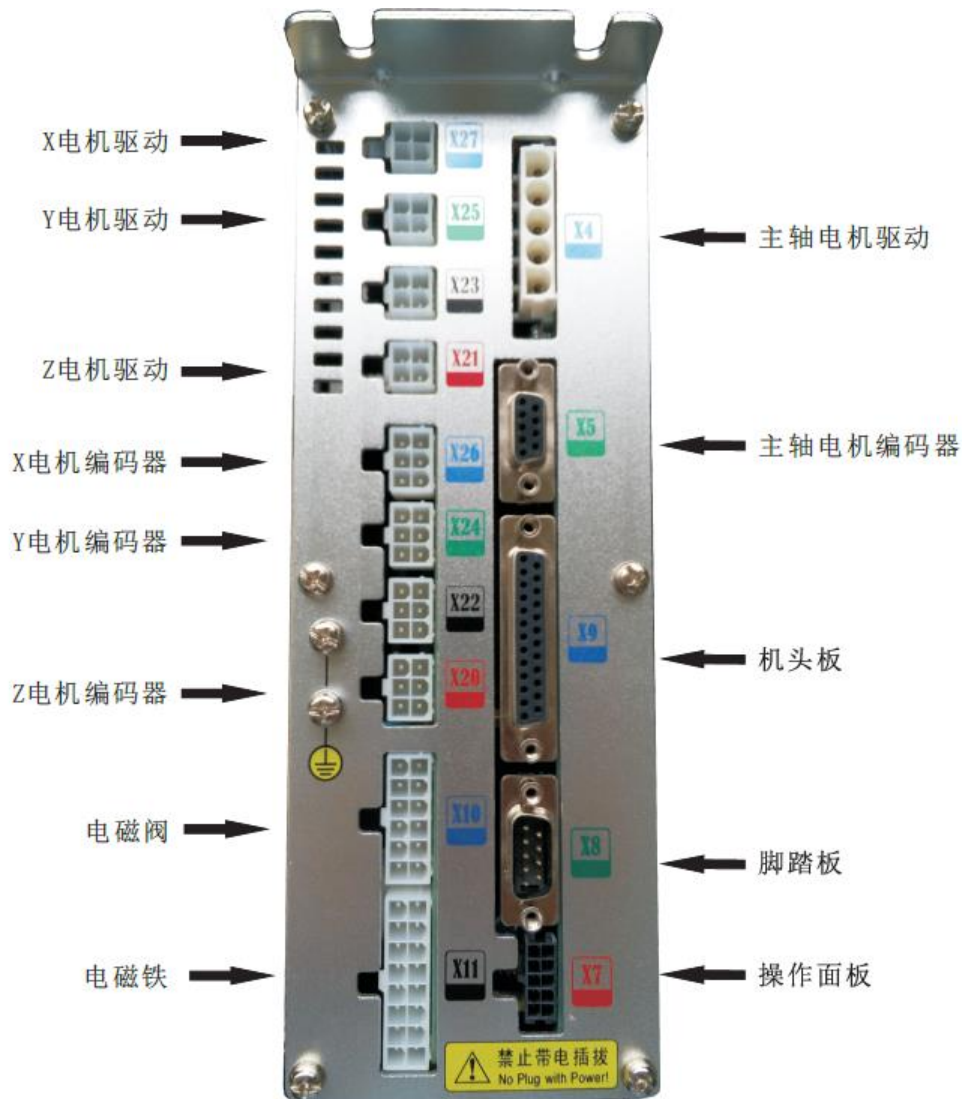

## 6.4 MASC511 圆头锁眼机系统框图

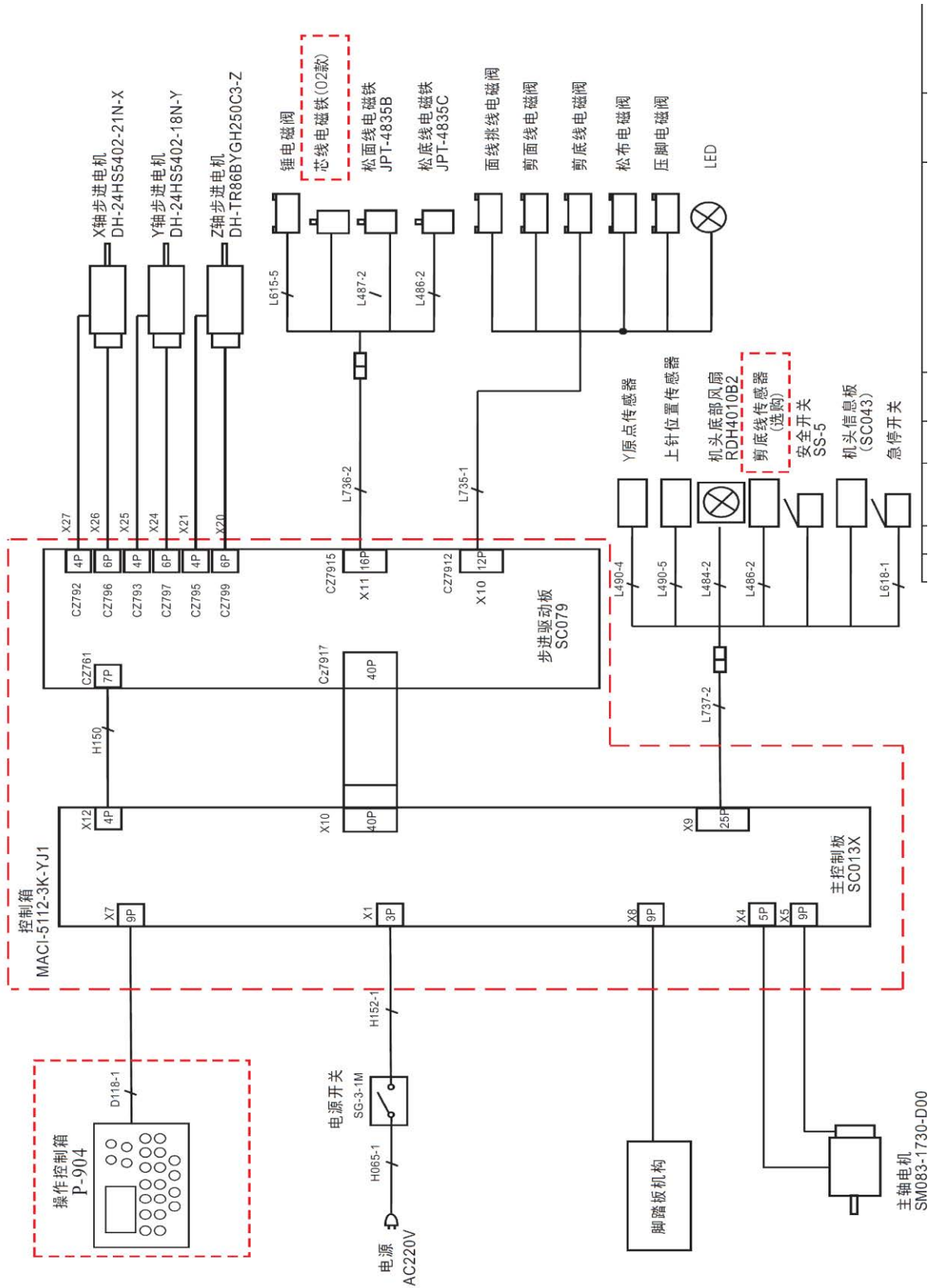



 高林股份有限公司  
KAULIN MFG. CO., LTD.

由於對產品的改良及更新，本產品零件圖及外觀的修改恕不事先通知！  
The specification and/or appearances of the equipment described in this parts list are  
subject to change because of modification which will without previous notice.  
BH9820.NOV.2018