

SIRUBA®

銀箭牌工業用縫紉機
INDUSTRIAL SEWING MACHINE

VC008/VPT

使用說明書 INSTRUCTION BOOK

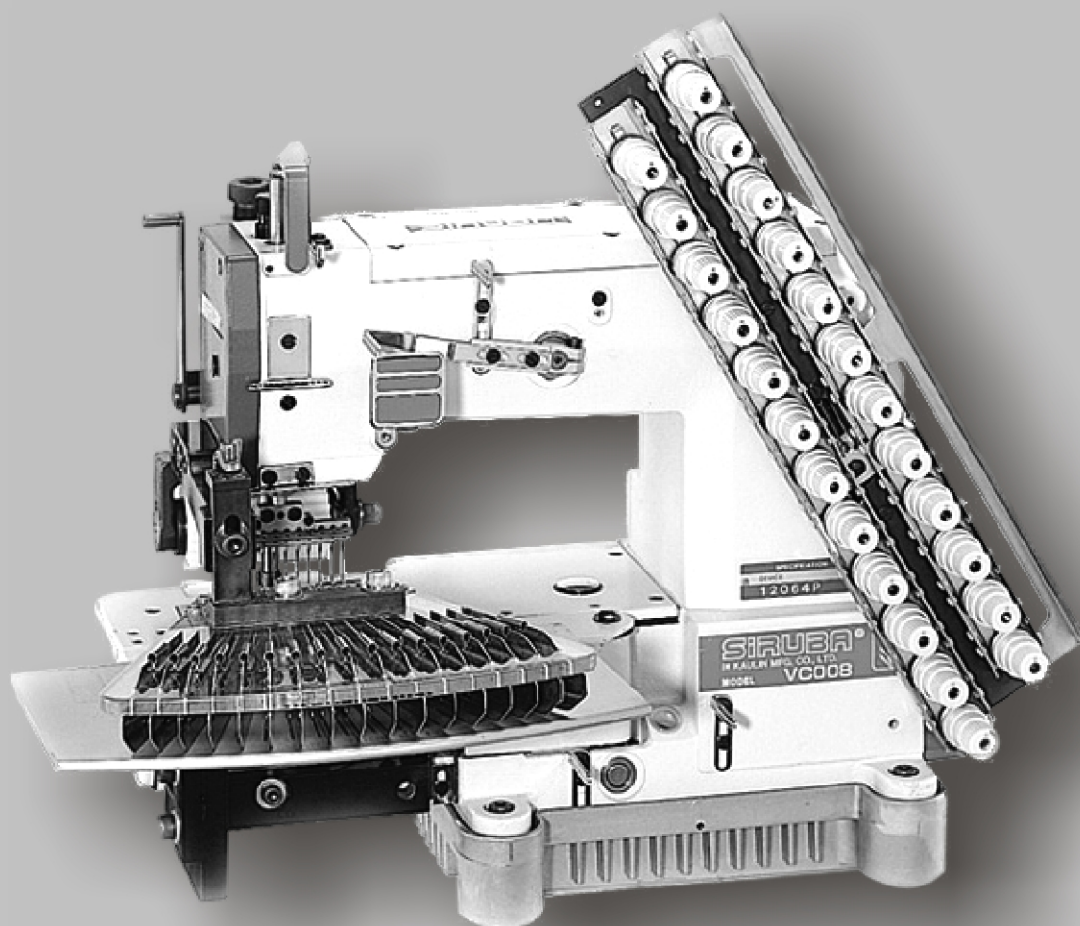

CE

 高林股份有限公司
KAULIN MFG. CO., LTD.

EC DECLARATION OF CONFORMITY

According to the following EC Directive

Machinery Directive : 98 / 37 / EC , as amended by 89/336/ EEC and 73/23/ EEC.

The undersigned, ROBERT TSAI , representing KAULIN MFG. CO., LTD. 11F 128 Sec. 3 Min Shen E. Road, Taipei , Taiwan ROC., manufacturer, declares that the machine described hereafter :

Multi-Needle Double Chainstitch Sewing Machine

Model :VC008

Provided that it is used and maintained in accordance with the generally accepted codes of good practice and the recommendations of the instructions manual, meets the essential safety and health requirements of the Machinery Directive.

For the most specific risks of the machine, safety and compliance with the essential requirements of the Directive has been based on elements of : the European Standard EN 292 - 1 & - 2 : 1992 Safety of machinery ; basic concepts, general principles for design.

The compliance of the model with the requirements of EC Machinery Directive was established by AIB-VINCOTTE Inter n.f.p, Avenue A. Drouart 27-29 , B 1160 , Brussels, Belgium (Notified body under the number 26 for machinery listed in annex IV of EC Machinery Directive).

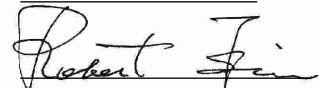

Date : JAN / 09 / 2007

Signature :





Qualification : R&D MANAGER

危險水準的說明 Explanation of Dangerous Level

| | |
|--|--|
|  危險 Dangerous | <p>如果忽視此標記而運行了錯誤的機械操作, 保養時肯定會引起當事者或第三者人員重傷或死亡</p> <p>Don't ignore the warning sign and don't proceed incorrect operation. Or it will cause the person or the third party seriously injured or dead during maintenance.</p> |
|  注意 Caution | <p>如果忽視此標記而運行了錯誤的機械操作, 保養時有可能會引起當事者或第三者人員受傷及造成設備損壞</p> <p>Ignoring this warning sign and proceed incorrect operation will cause the person involved or the third party wounded and equipment damaged during maintenance.</p> |

警告圖案表示及表示標誌的說明 Explanation of Warning Signs and Labels

| | | |
|---------------------------|---|--|
| 警告圖案表示 Warning Sign |  | 運動部位, 謹防工傷事故 Moving part, beware of industrial accident |
| |  | 高壓部位, 謹防觸電事故 High voltage, beware of electric shock |
| |  | 高溫部位, 謹防燙傷事故 High temperature, beware of burns |
| 指示標幟 Instruction Label |  | 禁止 Prohibited |
| |  | 地線的接線表示 Indication of ground wiring |

| 索引 | INDEX | 頁/PAGE |
|----------|-------------------------------|--------|
| 一般安全事項說明 | GENERAL SAFETY INSTRUCTIONS | 1 |
| 重要安全事項說明 | IMPORTANT SAFETY INSTRUCTIONS | 3 |
| 特別事項 | WARNING | 7 |
| 規格 | SPECIFICATIONS | 8 |
| 功能 | FUNCTIONS | 8 |
| 車縫型式 | SEWING TYPES | 9 |
| 針與褶板之關係 | NEEDLE AND THE BINDER | 11 |
| 零件說明 | PARTS DESCRIPTION | 12 |
| 零件圖 | PARTS LIST FOR VPT GROUP | 13 |
| 報廢流程 | DEMOLITION PROCEDURE | 14 |

警告！

當使用這台機器，基本安全預防應恆被遵守，以減輕火災、電擊、或是個人傷害的風險。包含以下注意事項。

在操作這台機器之前，請閱讀所有說明並且謹記於心。

- 1. 保持工作場所清潔**
雜亂的環境與椅子會招引危害。
- 2. 考量工作場所環境**
勿暴露電源於雨水之中、勿在濕氣重的地方或潮濕的場所使用機械器具。保持工作場所良好整齊。當有引發火災或爆炸危險時，勿使用電源工具。
- 3. 免於電擊危害**
避免身體接觸地線或是接地表面。(即：管線，發熱物體，以及冷凍庫)
- 4. 勿使孩童接近**
不要讓訪客碰觸工具或是延伸管線
- 5. 適當的穿著**
不要穿著寬鬆衣物或穿戴珠寶，這可能被活動零件拉扯而導致危險。穿戴護髮套以包含住長髮。
- 6. 不要任意拉扯電線**
絕不要用電線端拉扯機器，或是從插座猛拉電線來拔掉電線。使電線遠離熱源、油類或是尖銳邊緣。
- 7. 謹慎保養機器**
遵從指示來添加潤滑油或是更換附件。定期檢測工具用線，如果有所損害，請使用合格的維修器具來修復。

Warning!

When using this machine, basic safety precautions should always be followed to reduce the risk of fire, electric shock and personal injury, including the followings. Read all these instructions before operating this product and save these instructions.

- 1. Keep work area clean**
Cluttered areas and benches invite injuries.
- 2. Consider work area environment**
Do not expose power to rain. Do not use machine tools in damp or wet locations. Keep work area well lit.
Do not use power tools where there is risk to cause any fire or explosion.
- 3. Guard against electric shock**
Avoid body contact with earthed or grounded surfaces (e.g. Pipes, radiators, ranges refrigerators.)
- 4. Keep children away**
Do not let visitors touch the tool or extension code.
- 5. Dress properly**
Do not wear loose clothing or jewelry, they can be caught in moving parts. Wear protecting hair covering to contain long hair.
- 6. Do not abuse the cord**
Never carry the machine by cord or yank it to disconnect it from the socket. Keep the cord away from heat, oil, and sharp edges.
- 7. Maintain machine with care**
Follow instructions for lubrication and changing accessories. Inspect tool cord periodically. If damaged, have it repaired by an authorized service facility.

8. **分開機器**
當不使用機器時、維修前、以及更換配件時。
9. **避免誤啟動**
不要以手指置於啟動開關上之後，搬運一個已插入電源的工具。確定在插電之前，電源開關是關閉的。
10. **檢查損害零件**
在進一步使用器具之前，應該小心檢查並確認損傷的零件或是穿戴保護器具來確認零件會正確運轉並且呈現應有功能。
11. **警告**
除了在這本使用說明手冊中建議的功能之外，任何附件或是配件的使用，都可能會導致個人傷害的危險。
12. **由合格人員來修理事具**
所以的修理工作應該由合格的人員使用原始個別零件來作修理。

連接電源的特別警示

1. 只可與有"CE"認證的按壓啟動裝置連接這台機器。
2. 遵守此使用說明手冊來安裝控制裝置。
3. 在操作過程中，永遠保持機器適當的接地。
4. 在調整、更換零件、或是維修保養之前，必須確定將插頭由插座拔出，以預防任何機器意料之外的啟動而造成危害。







8. **Disconnect machine**
When not in use, before servicing and when changing accessories.
9. **Avoid unintentional starting**
Do not carry a plug-in tool with a finger on the switch. Ensure the power switch is off when plugging in.
10. **Check damaged parts**
Before further use of the tool, a guard or other part that is damaged should be carefully checked to determine that it will operate properly and perform its intended function.
11. **Warning**
The use of any accessory or attachment, other than those recommended in this instruction manual, may present a risk of personal injury.
12. **Have your tool repaired by a qualified person**
Repairs should only be carried out by qualified persons using original spare parts.

SPECIAL WARNING FOR ELECTRIC CONNECTION!

1. Incorporate this machine only with "CE" certificate hold-to-run control device.
2. Follow the instruction manual device to install control device.
3. Always earth machine appropriately during operation.
4. Before adjustment, parts change or servicing must be sure to pull out the plug from socket to prevent the hazard of unintentionally start of machine.







重要安全事項說明

恭喜您購買本機器, 為了使這台機器能獲得最佳功能以及安全的操作, 務必請正確的使用這台機器, 使用前請仔細閱讀使用說明書, 希望您能長期使用它。請記得將此說明書放在容易取得的地方。

-  1. 當您使用機器時, 除了以下事項外, 請注意其他基本安全措施。
-  2. 使用機器前, 除了這本使用說明書外, 請詳細閱讀其他有關說明書。此外, 請妥為保存這本使用說明書, 以便需要時可以隨時取閱。
-  3. 先確認機器是符合貴國安全規定及標準後, 再使用機器。
-  4. 當機器完成操作準備時, 所有安全配備必需安裝就緒, 在缺少所述安全配備下操作是不被允許的, 以免導致人員受傷。
-  5. 此機器應由受過適當訓練之操作員操作。
-  6. 為了安全, 我們建議您配戴安全眼鏡。
-  7. 以下情形, 請先關閉電源或拔掉插頭:
 - (1) 穿針線、線導片、天平等以及更換梭子時,
 - (2) 更換針、押具、針板、送具、頂針片、喇叭、車布導板, 以及其他附屬配件時。

IMPORTANT SAFETY INSTRUCTIONS

For operating safely and getting the best functions of this machine, you must operate it correctly. Please read and follow the instructions of this manual, and keep it at hand for future references. We are confident that you will enjoy this machine as much as we enjoy manufacturing it.

-  1. Instead of the following instructions, when you use this machine, please pay attention to the basic safety measures.
-  2. Before using this machine, please read this manual and all related instructions. In addition, please keep this manual for future needs.
-  3. Before using this machine, please ascertain that it conforms with safety standards and regulations of your country.
-  4. When the machine is ready for operation, all the safety equipments must be ready. Operate this machine without the specified safety devices is not allowed.
-  5. This machine must be operated by a properly trained operator.
-  6. For your own safety, we suggest you wearing goggles.
-  7. Please turn off the power switch or disconnect it for any one of the circumstances of the followings:
 - (1) When threading needle(s), adjusting thread Take-up(s), thread guide(s), and / or replacing bobbin(s),
 - (2) When replacing needles, presser feet, needle plates, feed dogs, needle guards, horns, cloth guides and other parts or accessories,

- (3) 維修工作時。
- (4) 離開工作場所或工作場所無人看顧時。
- (5) 若使用離合器馬達而無煞車片裝置時，必需待馬達完全停止。



8. 假如不慎讓機器及配件使用之油或油脂，接觸到眼睛、皮膚或誤食時，請立刻以水清洗接觸部位及就診。



9. 請勿擅自碰觸運轉中之零件及配件及注意機器電源是否已開啟，以免導致人員受傷。



10. 維修、修改及調整等工作，需由受過適當訓練的技師或熟手為之。維修時只許使用指定之零件。



11. 一般維修及檢查工作必須由受過適當訓練的人員為之。



12. 電子零件維修及保養工作必須由資深的電子技師為之，或由非常熟練的人員檢查及指導，當發現零件損壞時，請立刻停止機器運轉。



13. 在做裝有氣動式零件(例如氣缸)機器的維修及保養工作前，機器連接空壓機及高壓空氣必須予以關閉及卸除，機器中殘存高壓氣體必需予以消除，此外調整及性能檢查只能由受過適當訓練的技師或熟手為之。



14. 機器使用一段時間，必需定期清理。

- (3) When repairing,
- (4) When the operator leaves the working place or leaves the machine unattended.
- (5) If clutch motors without brake pads are used, must wait until the motor stops completely.



8. If grease, oil, or any fluid contacts your skin or eyes by any chance, please wash the contacted area completely with clean water and consult a doctor. Or, swallow any fluid mistakenly, consult a doctor immediately.



9. Do not touch any functioning parts and devices. Always attend to whether power switch is on or off before operating in order to prevent anyone from getting hurts.



10. Qualified technicians are required for adjustment, modification, and repair. Only use assigned parts for replacement.



11. Routine maintenance and service must be performed by well trained persons , or qualified technicians.



12. Maintain and check the electronic parts must be done by qualified electrician or well-trained persons. If any electronic part damaged or malfunctioned, stop the machine immediately.





13. The air hose has to be detached from the machine and the compressor or air supply has to be cut off before repairing and servicing the machine equipped with pneumatic parts such as an air cylinder. Qualified technicians or well-trained persons are required for adjustment and repairs.



14. To ensure the best performance, periodically clean the machine is necessary.

 15. 為使機器能正常操作及減少噪音，機台務必平放地上，機器避免在強烈噪音的環境下操作。

 16. 選用適當的電源插頭，並由電子技師將其按裝在機器上，且插頭必需插在接地線之插座上。

 17. 機器只允許被使用於指定用途上，其他用途是不允許的。

 18. 修改或變更機器必需依照安全規定及標準，同時採取有效的安全措施，本公司不承擔任何私自因修改或變更機器所引起損壞之責。

19. 警告提示以兩種符號標示：

 (1) 對操作員或服務人員之傷害危險，也為了避免觸電之危險，請勿打開馬達電器箱之外蓋，也不要觸摸電器箱裡面之零件。

 (2) 必需特別注意事項
a. 絕對不可在移開皮帶蓋，手指保護蓋或安全配件後，進行機器操作，以免導致人員受傷。

 b. 為了避免被機器纏住，當機器運轉中，您的手、頭髮及衣服，需遠離手輪，皮帶及馬達；此外這些部位周圍不可放置任何物品，以免導致人員受傷。

 15. In order to operate properly and to reduce the noise, please place the machine flat and level on the ground. Avoid operating the sewing machine at a noisy surrounding.

 16. Select a proper power plug and install it by an electrician. Please connect the power plug to a grounded receptacle.

 17. This machine can only be used for the designed purpose. Other uses of this machine are not allowed.

 18. Any modification or conversion made on this machine must be conformed with the safety standards and regulations. Precaution is necessary. No responsibility will our company take for damages caused by any modification or conversion of this machine without permission.

19. Two safety warning signs are applied as warning signs:

 (1) For the safety of operators and service persons, please don't open the cover of any electronic control boxes of motor or other devices and don't touch any components inside to avoid electrical shock hazards.

 (2) Always keep in mind :
a. Please never operate this machine without belt cover, finger guard or any safety device to avoid physical injury.

 b. Please keep your hair, fingers and cloths away from the hand wheel, V belt and motor while the machine is in operation, as well as never put anything near these parts, to prevent the risk of injuries by tangled into them.



- c. 當您打開電源開關後或機器已在運轉中，絕不可將您的手放在針的下方或針線控線桿外蓋中，以免導致人員受傷。



- c. Please never put your fingers under the needle(s) or in the thread take-up cover to prevent physical injuries when you turn on the power switch or operate the machine.



- d. 當機器運轉中，梭頭高速轉動，為了避免對手可能引起之傷害，必需確定您的手保持遠離梭頭附近。此外，當更換梭子時，確定電源開關已關閉，以免導致人員受傷。



- d. While the machine is in operation, the hook rotates at a high speed. Please keep your hands away from the area of hook to prevent any potential injury to your hands. In addition, please make sure to turn off the power of the machine while changing bobbins.



- e. 當放置或抬起機頭時，小心勿將手置於機器中，以免導致人員受傷。



- e. Be careful and do not place your fingers inside the machine when placing or lifting the machine head to avoid possible physical injuries.



- f. 為了避免機器突然啟動而引起可能意外，當機頭傾斜或移開皮帶蓋及皮帶時，請關掉機器電源，以免導致人員受傷。



- f. Please turn off the power before tilting the machine head or removing the belt cover and the V belt to avoid possible accidents due to abrupt start of this machine.



- g. 如果您的機器是配置伺服馬達，機器於靜止狀態時，馬達是不會產生噪音的，為了避免機器突然啟動而引起可能意外，故請關掉機器電源。



- g. For machines equipped servo motors, the motors do not produce noise while the machines are at rest.

Therefore, please turn off the power of this machine to avoid possible accidents due to abrupt start of the machine.



- h. 為了避免觸電之危險，請絕不要在移開電源接地線後操作機器。



- h. Never operate the sewing machine after the ground wire is removed to avoid electrical shock hazards.



- i. 為了避免觸電或電子零件損壞而引起之可能意外，請先切斷電源，再插上或拔掉插頭。



- i. Please turn the power switch off before connecting or disconnecting the power plug to prevent possible accidents due to electric shock or damaged electronic components.

特別事項

WARNING

為了避免機器故障及損壞，請先確定以下事項：







1.  當您安裝好機器後，做第一次機器操作前，請徹底清潔機器。
2.  清除運送途中累積之灰塵及溢出之油脂。
3.  確定電壓及馬達相數(單相或三相)安裝正確。
4.  確定電源插頭正確地接上電源。
5.  當使用電壓與標示電壓不同時，請勿使用機器。
6.  確定機器轉動方向是否正確。



警告：

在操作或調整本書中所提到之各步驟前，請先將電源關掉，以免因為機器突然啟動造成之意外。

Please confirm the followings to avoid malfunction or damage to this machine.

1.  After installing the machine, and before the first operation, please clean it completely.
2.  Clean all dust and overflowed oil during transportation.
3.  Confirm that the voltage and the phase (single or 3 phase) of motor are set correctly.
4.  Confirm that the power plug is correctly connected to the power supply.
5.  Never use the machine when the local voltage type is different from the marked voltage on the nametag attached on the machine.
6.  Confirm that the rotating direction of the machine pulley is correct.



Warning :

Before doing any operation or any adjustment described later in this manual, please turn the power off to prevent accidents caused by abrupt start of the sewing machine.

規格**SPECIFICATIONS**

| | |
|-------------------------------|---|
| 適用機型 FOR MODEL | VC008-12048P/12064P |
| 車縫型方式 SEWING TYPE | 勾針縱向多針雙重鏈式縫 Looper Style Longitudinal Multi-Needle Double Chainstitch |
| 車縫速度 SEWING SPEED | 2500 S.P.M |
| 針寬 NEEDLE WIDTH | 3/16" (12048P) 1/4" (12064P) |
| 使用針 NEEDLE USED | DV57 #75~90 |
| 後拉引輪 REAR PULLING WHEEL | 膠質平輪 Rubber Flat Wheel |
| 針棒行程 NEEDLE BAR STROKE | 24 mm |

功能**FUNCTIONS**

1. 多種變化摺襟縫紉，導邊器可隨意交換，所以即使使用一台單一的機器就可有多種類的變化，此系列中的機器可做出右傾或左傾摺襟縫。
 2. 因供應多種的導邊器，可隨自己用途所需做適當的調整，如襯衫、衣裙、衣服、兒童襯衫等之摺襟用。
1. Variable tucking styles with a changeable fabric guide. Therefore, even use one single machine will have variable results. Besides, for this series, you can do right side or left side tucks.
 2. Because many kinds of the fabric guide are available, you can do suitable adjustments based on different uses, such as shirts, skirts, clothes, child shirts.

1. 導線器

明摺縫：2 mm，5 mm和8 mm左傾和右傾
多針摺襟縫。(圖1)

1. Fabric guide

Tucking: 2 mm, 5 mm, and 8 mm lift side or
right side multi-needle tucking. (Fig. 1)



圖1/ Fig. 1

說明：

以5 ML為例：5 M為摺襟寬，L為左傾。

Description:

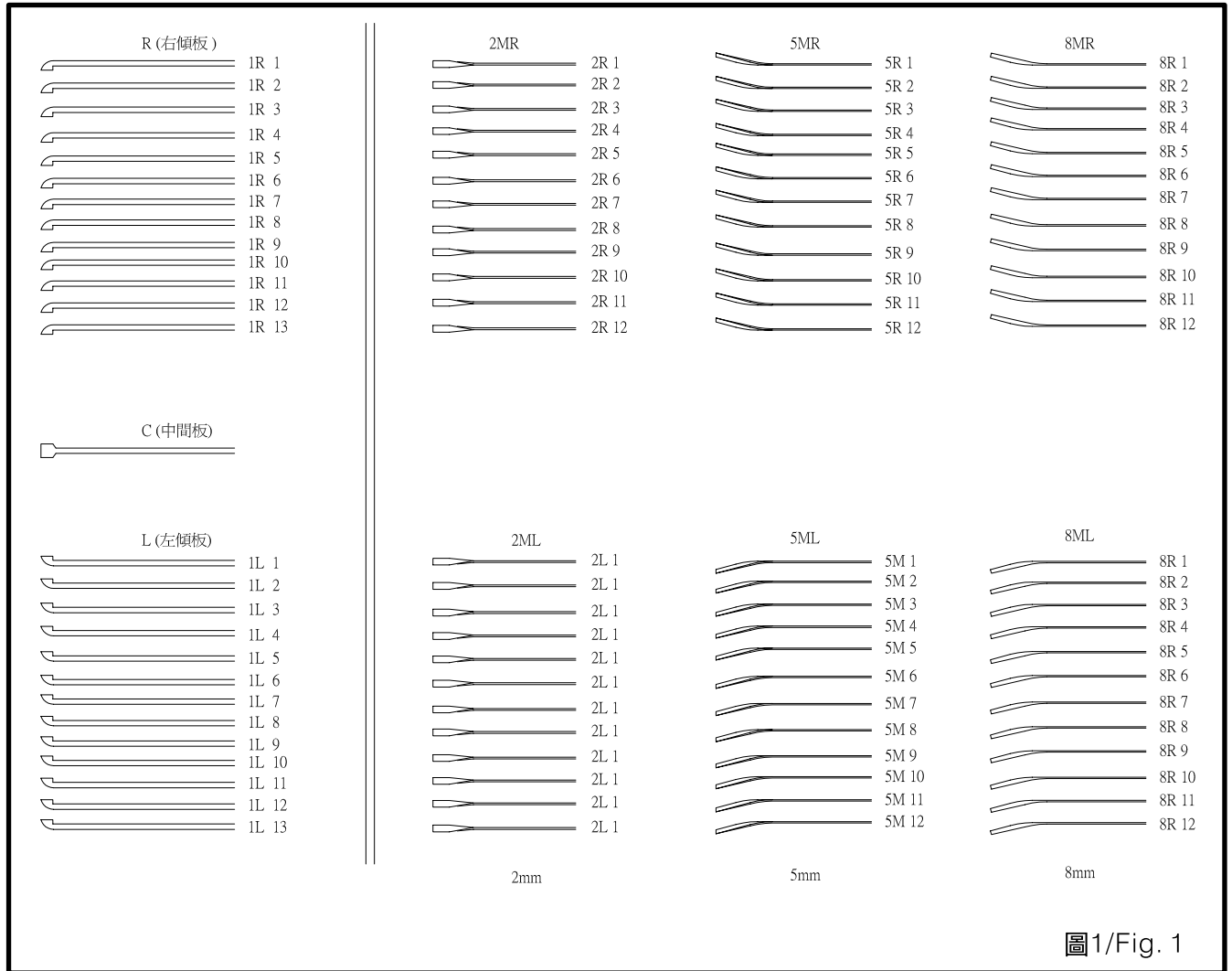
Take 5ML as example: 5M means the tuck width, and L means the tucks are left ones.

說明：

以5 ML為例：5 M為摺襟寬，L為左傾。

Description:



圖2/Fig. 2

說明：(圖3)

Description: (Fig. 3)

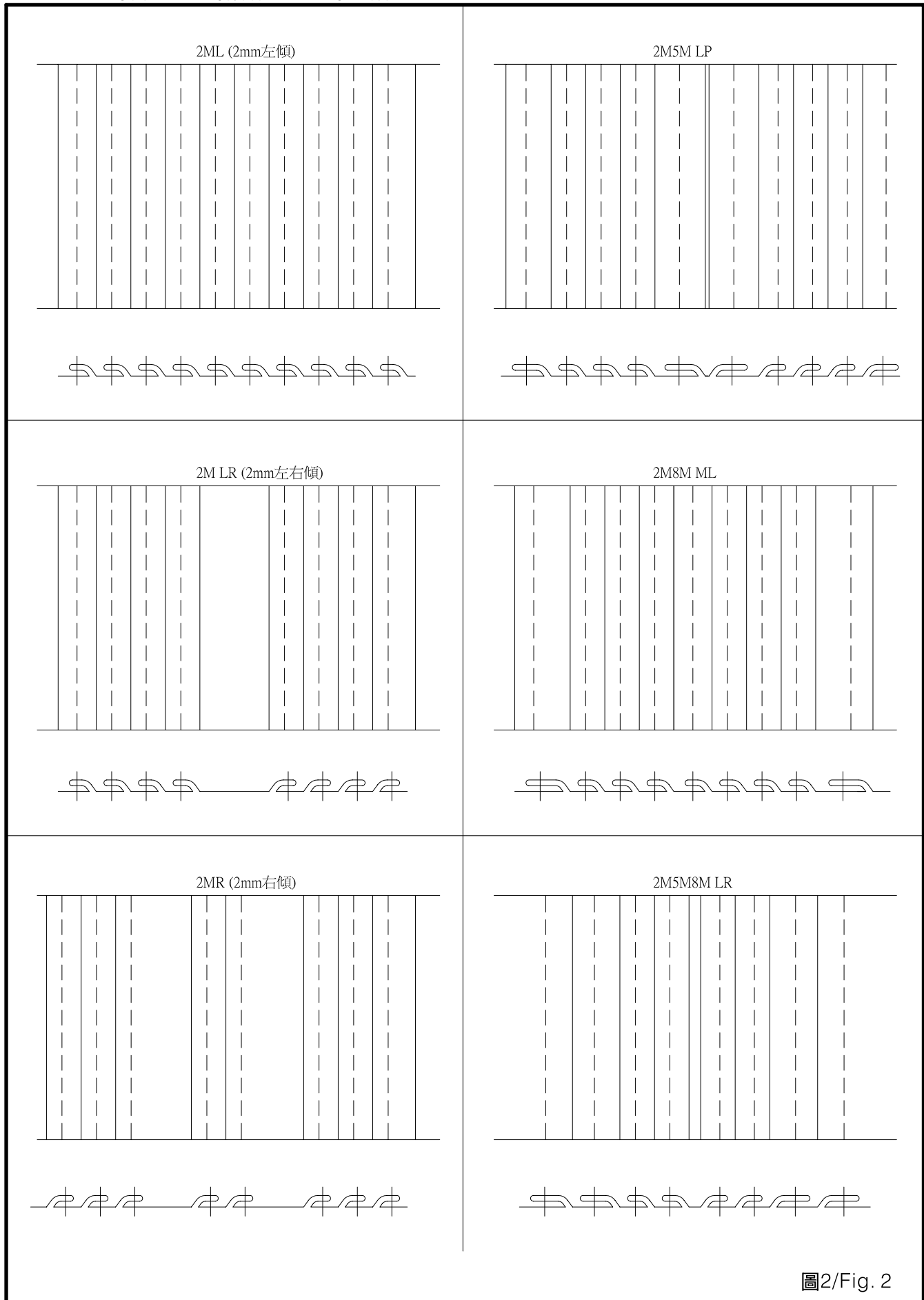

圖3/Fig. 3

針與褶板之關係

NEEDLE AND THE BINDER

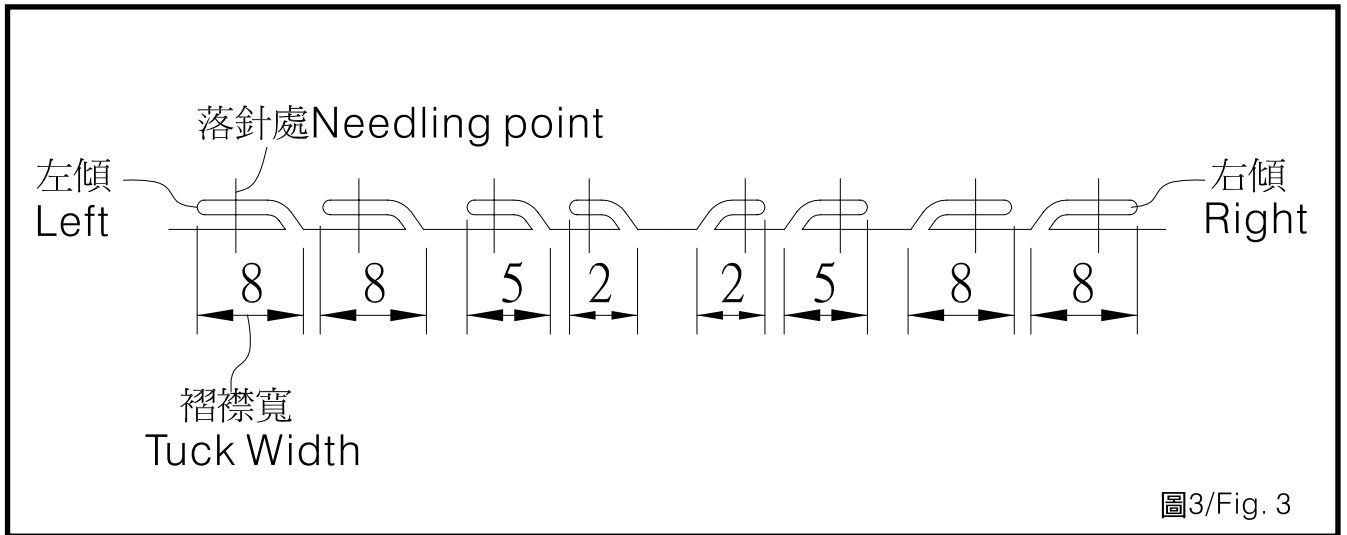

圖4/Fig. 4



圖5/Fig. 5

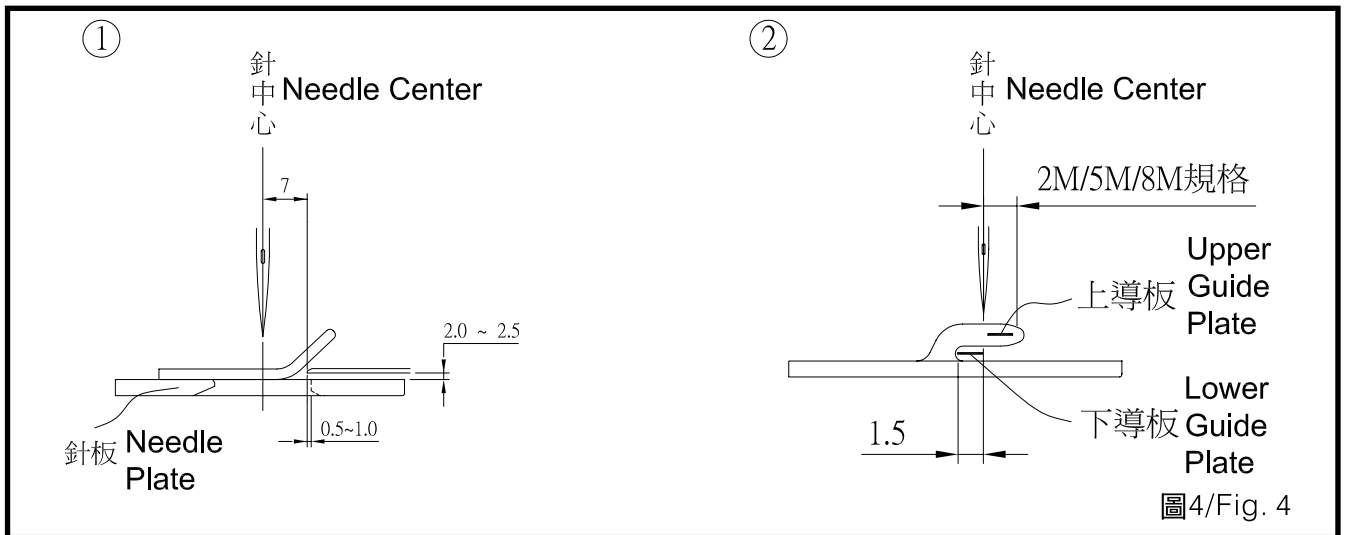

零件說明

PARTS DESCRIPTION

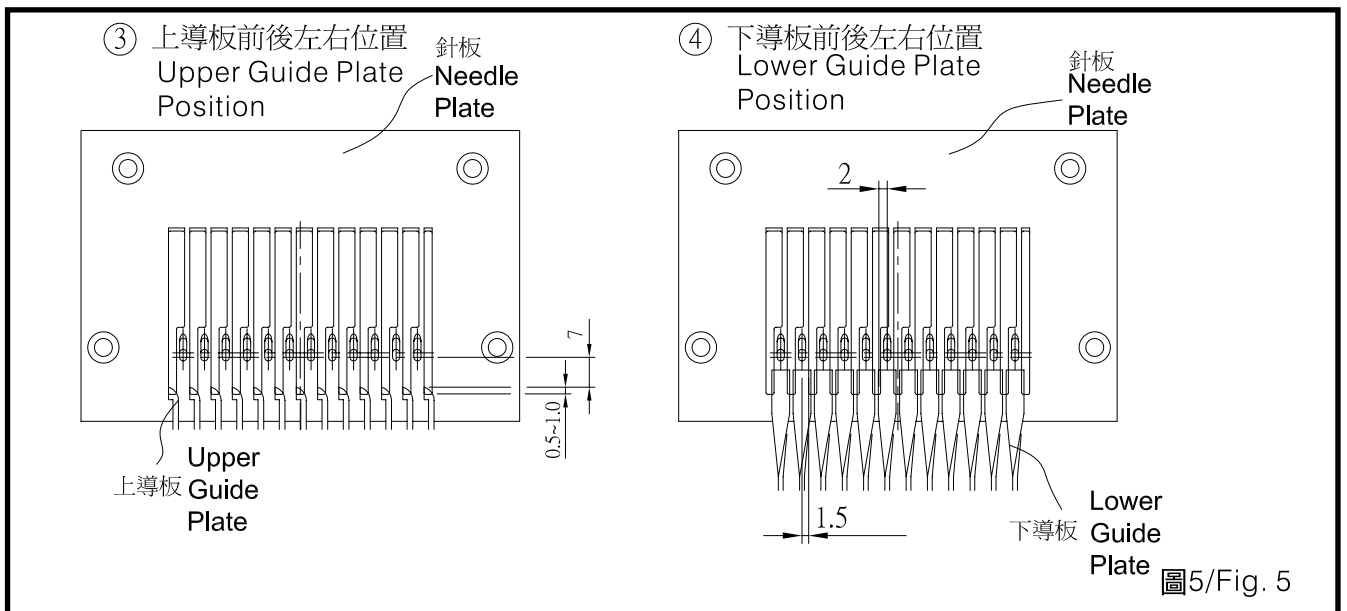
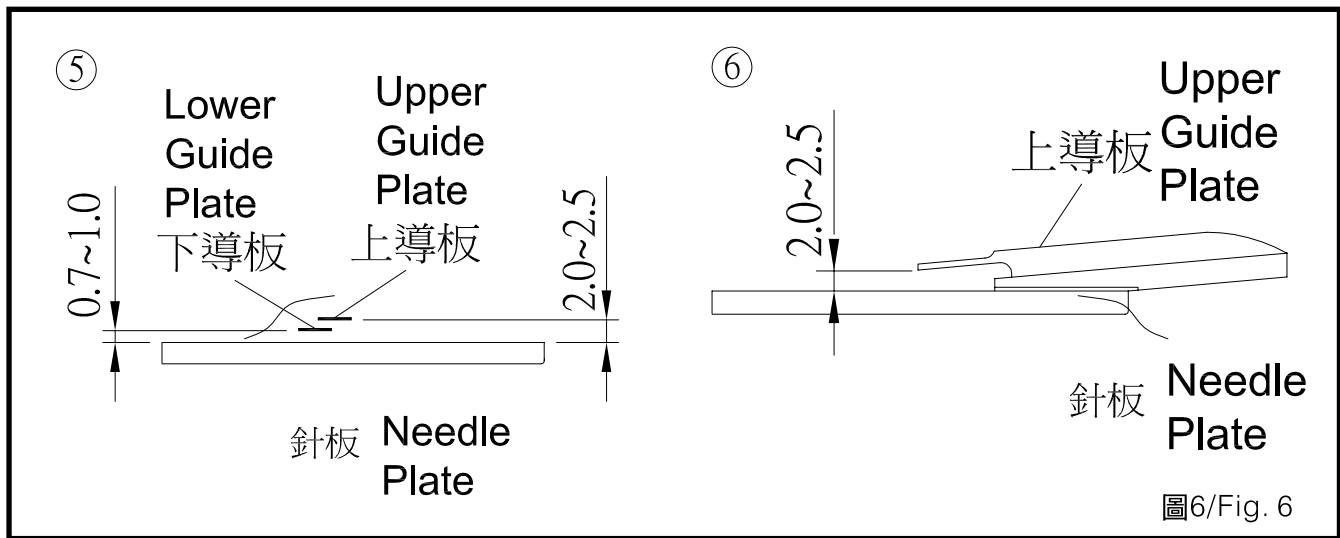
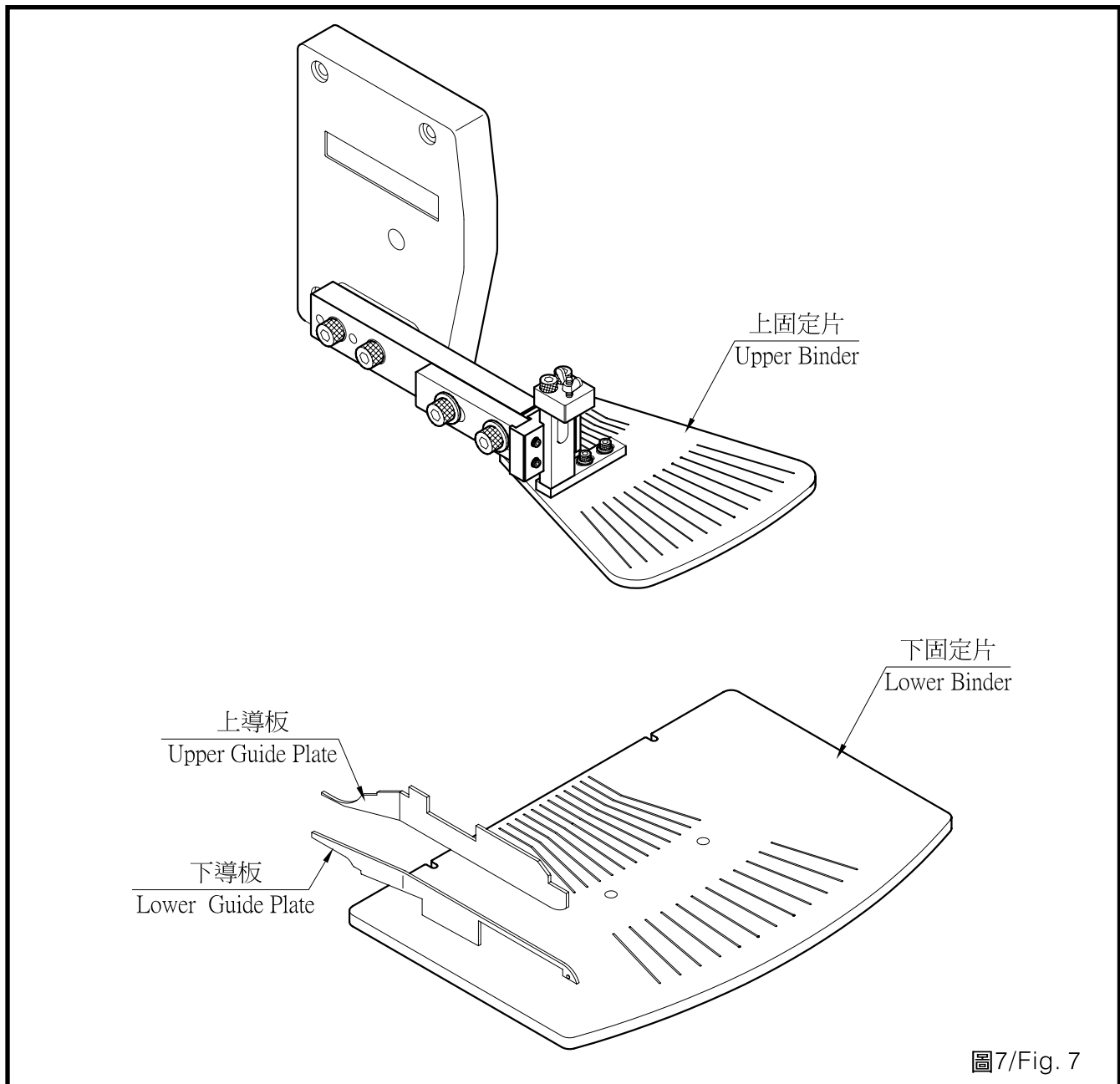

報廢流程

DEMOLITION PROCEDURE

1. 當機器需要被淘汰與報廢時，有一些基本規則必須採納、遵守以保護環境及公眾健康。
 2. 所有的機器零組件必須依照下列分類來區分開：
 - (1) 所有護套、可伸縮軟管及塑膠或非金屬零件。
 - (2) 電器零件：開關、照明器具等。
 - (3) 絕緣材料：石棉、彈性/可伸縮橡膠片。
 - (4) 金屬：含鐵金屬、銅、青銅與黃銅、其他各種金屬。
 3. 以此方法，所有材質可以正確的淘汰，回收再利用或鎔解為可再使用或再處理而不至於危害環境。
1. When the machine needs to be eliminated and demolished, certain basic rules must be observed to protect the environment and public health.
 2. ALL machine componenets must be divided according to categories as the followings:
 - (1) All sheathes, flexible hosing and plastic or non-metal components.
 - (2) Electricity components: switches, or lighting components.
 - (3) Insulation materials: rock wool, and flexible rubber strips.
 - (4) Metals: ferrous metals, copper, bronze and brass, various.
 3. In this way, all materials can be eliminated correctly, recycled, or melted down for re-use or disposed of so that they do not harm the environment.



VC008/VPT

高林股份有限公司 KAULIN MFG. CO., LTD.