

PARTS BOOK

KM-76

스끼기

Leather Skiving Machine

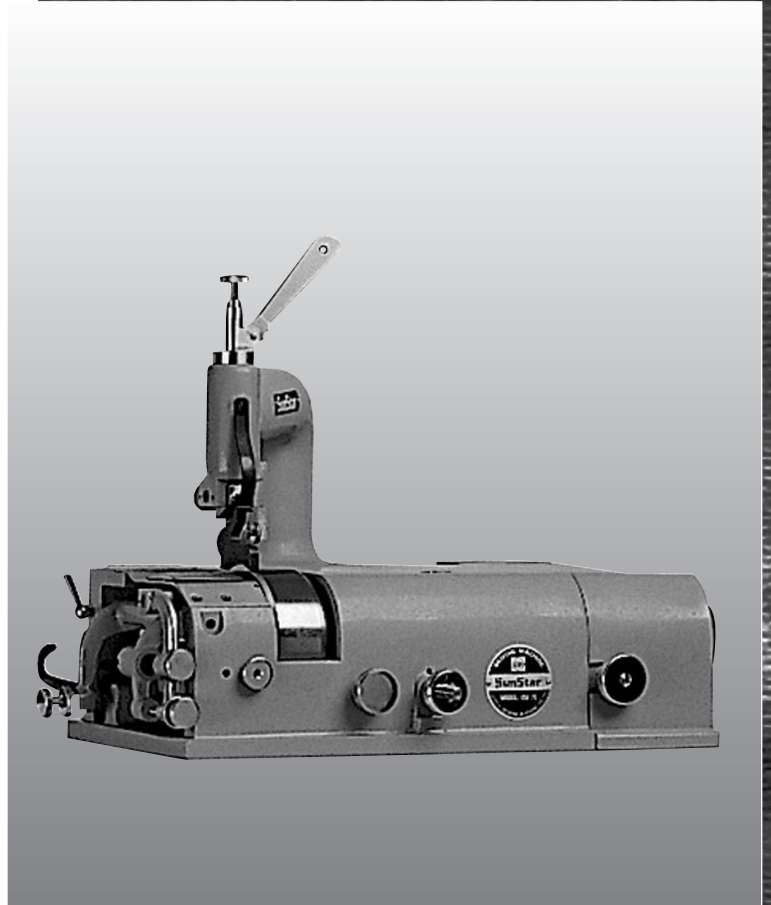

PME-051019

SUNSTAR MACHINERY CO., LTD.

CONTENTS

목 차

A	<i>Presser Foot & Outer Attachments</i> 누름대 및 외장관계	4
B	<i>Knife & Related Parts</i> 칼날 축 및 폴리축 관계	6
C	<i>Grindstone & Roller Related Parts</i> 저석 및 로울러 관계	8
D	<i>Accessories</i> 액세서리	12

A

Presser Foot & Outer Attachments 누름대 및 외장관계

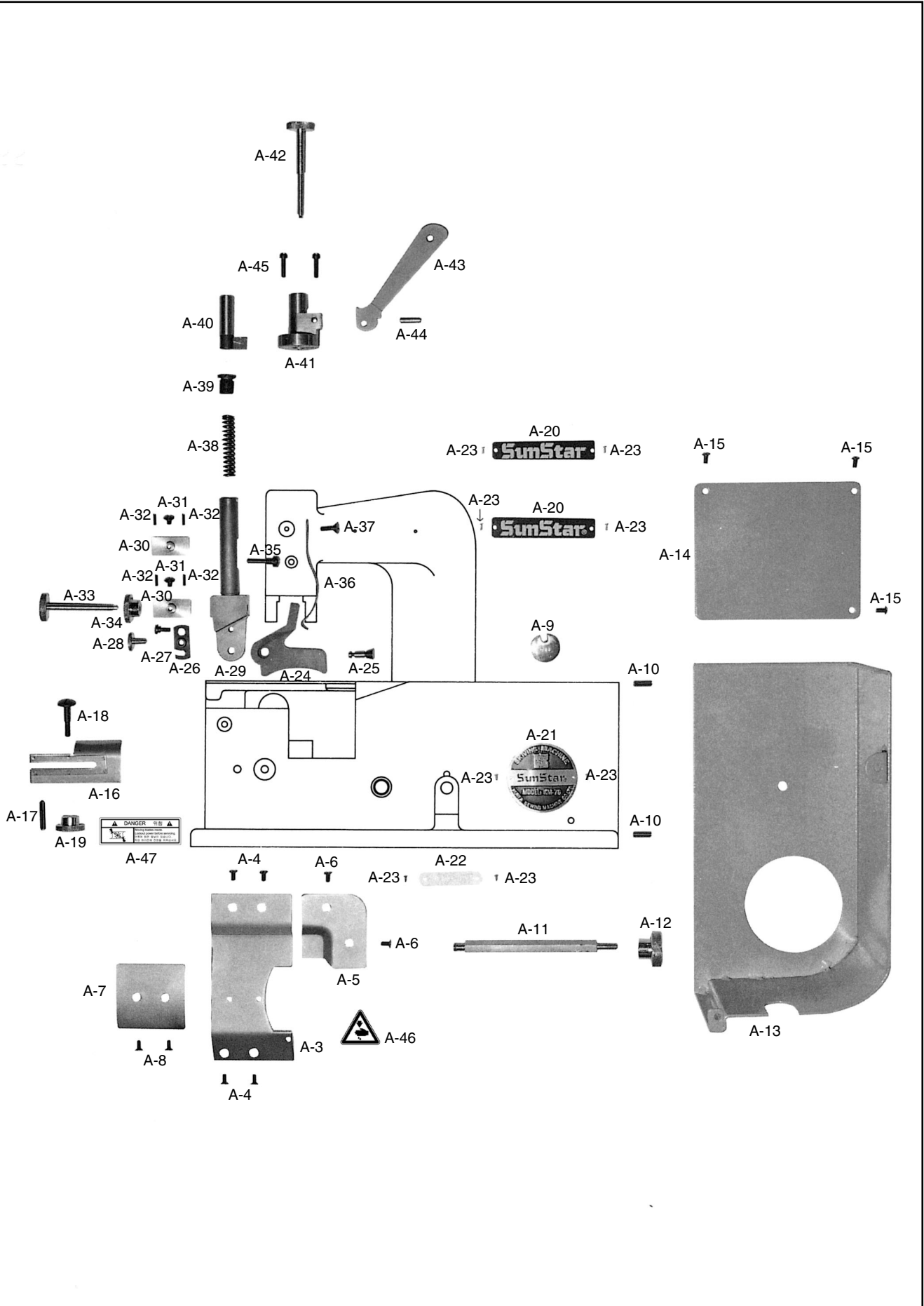



Ref. No.	Parts No.	Note	Name of Parts	품 명	Q' ty	Assembly No.
A-1	01-002A-7600		Arm	암	1	
A-2	01-003A-7600		Bed	베드	1	
A-3	01-006A-7600		Slide Plate(A)	미끄럼 판(A)	1	
A-4	01-007S-7600		Screw(11/64" n=40)	미끄럼 판 쥘나사(11/64" n=40)	4	
A-5	01-008A-7600		Slide Plate(B)	미끄럼 판(B)	1	
A-6	01-007S-7600		Screw(11/64" n=40)	미끄럼 판 쥘나사(11/64" n=40)	2	
A-7	01-009A-7600		Slide Plate(C)	미끄럼 판(C)	1	
A-8	01-007S-7600		Screw(11/64" n=40)	미끄럼 판 쥘나사(11/64" n=40)	2	
A-9	01-011A-7600		Oil Cap	오일 캡	1	
A-10	01-006P-7600		Waste Feeder Stop Pin	벨트 커버 지지핀(5×15)	2	
A-11	01-048S-7600		Belt Cover Lid Stopper Screw	벨트 커버 고정 볼트	1	
A-12	01-049C-7600		Belt Cover Lid Stopper	벨트 커버 고정 볼트 너트	1	
A-13	01-046A-7600		Belt Cover	벨트 커버	1	
A-14	01-247C-7600		Belt Cover Lid	벨트 커버 측면	1	
A-15	SC-0543-2302		Screw(11/64" n=40)	톱카바 힌지 고정나사(11/64" n=40)	3	
A-16	01-127A-7600		Waste Feeder Metals(Set)	천조각 안내판	1	
A-17	43-008C-3400		Waste Feeder Stop Pin	무릎올림 레버 스톱퍼(6×25)	1	
A-18	SC-0333-7600		Screw(15/64" n=28)	천조각 안내판 쥘나사(15/64" n=28)	1	
A-19	01-102C-7600		Roller Bracket Turning Arm Adjusting Screw Nut	로울러 브라켓 암 조절 나사 너트	1	
A-20	01-180M-7600		Brand Mark	브랜드 마크	2	
A-21	01-181M-7600		Model Mark	기종 마크	1	
A-22	01-035P-1230		Machine Number Plate	번호판	1	
A-23	01-035P-7400		Setting Pin	번호판 핀	6	
A-24	01-157A-7600		Presser Foot(50mm)	노루발"A"(특대)	1	
A-25	01-161A-7600		Presser Foot Shaft	노루발 고정축	1	
A-26	01-162A-7600		Presser Foot Shaft Hook Metal	노루발 고정축 걸이	1	
A-27	01-163S-7600		Presser Foot Shaft Hook Metal Hinge Screw	노루발 고정축 걸이 쥘나사	1	
A-28	SC-0220-7600		Screw(3/16" n=28)	노루발 쥘나사(3/16" n=28)	1	
A-29	01-165A-7600		Presser Bar	누름대(K2670)	1	
A-30	01-268A-7600		Presser Foot Side Plate	누름대 안내판	2	
A-31	SC-0527-7600		Screw(3/16" n=28)	누름대 안내판 쥘나사(3/16" n=28)	2	
A-32	SC-0359-7600		Screw(9/64" n=40)	누름대 안내판 조정나사(9/64" n=28)	4	
A-33	01-101S-7600		Roller Bracket Turning Arm Adjusting Screw	로울러 브라켓 회전 암 조절 나사	1	
A-34	01-102C-7600		Roller Bracket Turning Arm Adjusting Screw Nut	로울러 브라켓 암 조절 나사 너트	1	
A-35	SC-0345-7600		Screw(15/64" n=28)	누름대 스프링 쥘나사(15/64" n=28)	1	
A-36	01-169G-7600		Presser Foot Spring	노루발 스프링	1	
A-37	01-179S-7600		Presser Foot Spring Screw	노루발 스프링 쥘나사	1	
A-38	01-171G-7600		Presser Bar Spring	누름대 스프링	1	
A-39	SC-0319-7600		Screw(1/2" n=28)	누름대 스프링 덮개나사(1/2" n=28)	1	
A-40	01-375A-7600		Presser Bar Lifter Lever	누름대 잡이	1	
A-41	01-376A-7600		Presser Bar Lifter Bracket	누름대 올리기 브라켓	1	
A-42	01-178S-7600		Presser Bar Adjusting Screw	압력조절나사	1	
A-43	01-173A-7600		Presser Bar Lifter	누름대 올리기(K1812)	1	
A-44	01-174P-7600		Presser Bar Lifter Pin	누름대 올리기 힌지핀	1	
A-45	SC-0526-7600		Screw(3/16" n=28)	누름대 올리기 브라켓 쥘나사(3/16" n=28)	2	
A-46	01-060M-300G		Warning Sign Sticker	위험표시 스티커	1	
A-47	GP-010088-01		Danger Sticker	위험 스티커	1	

B

Knife & Related Parts 칼날축 및 플리축 관계

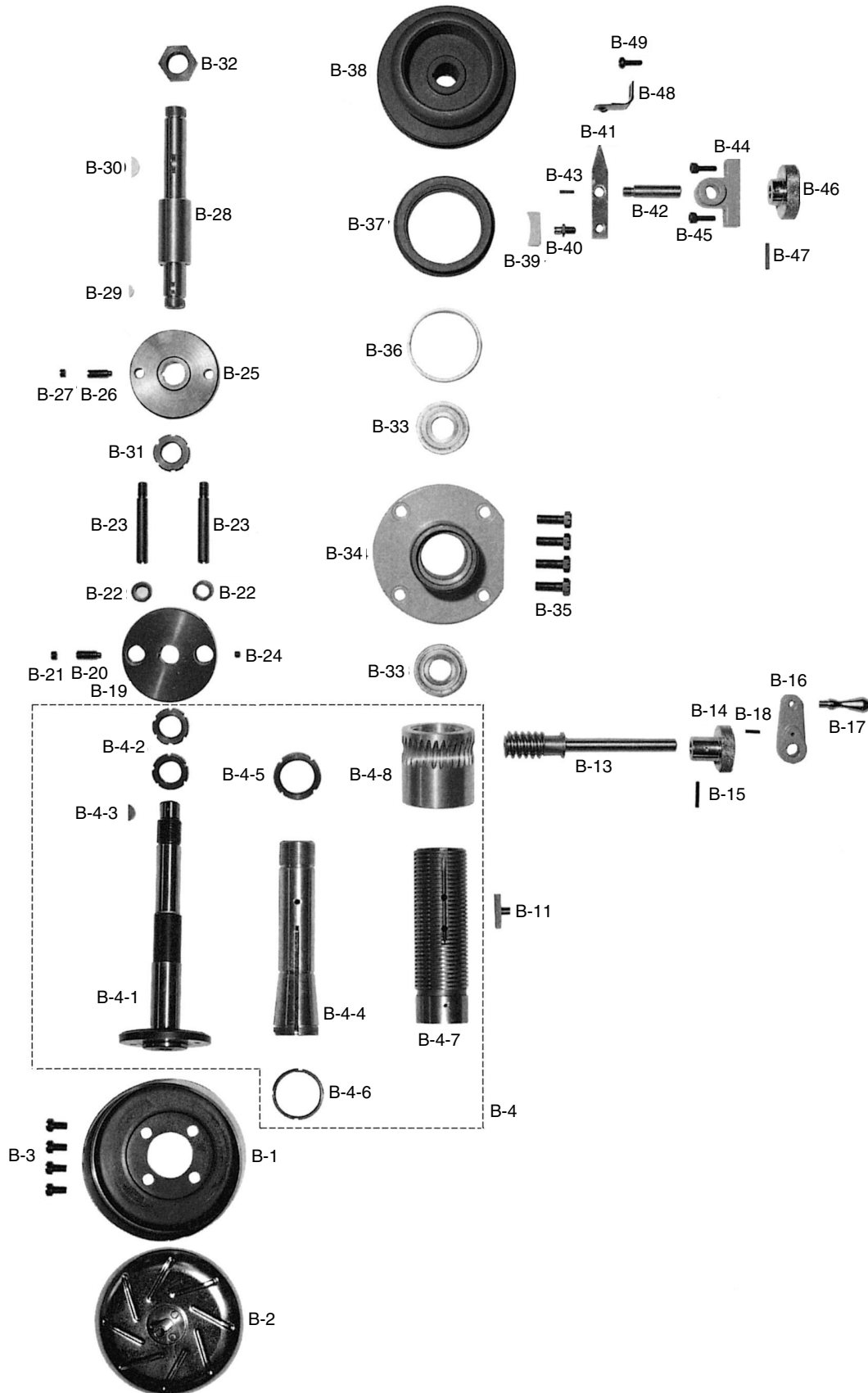



Ref. No.	Parts No.	Note	Name of Parts	품 명	Q' ty	Assembly No.
B-1	01-014A-7600		Knife	칼날	1	
B-2	01-030A-7600		Knife Inner Cover	칼날 내면 커버	1	
B-3	SC-0197-7600		Screw(M6×1.0)	칼날 쥘나사(M6×1.0)	4	
B-4	01-115A-7600		Knife Shaft Ass'y	칼날 축		
B-4-1	01-015A-7600		Knife Shaft	칼날 축	1	
B-4-2	01-033A-7600		Knife Shaft Nut	칼날 축 너트	2	
B-4-3	01-022C-7600		Knife Shaft Key	칼날 축 키(3×13)	1	
B-4-4	01-016A-7600		Knife Shaft Metal	칼날 축 붓싱	1	
B-4-5	01-035A-7600		Knife Shaft Metal Nut	칼날 축 붓싱 너트	1	
B-4-6	01-036A-7600		Knife Shaft Metal Nut(B)	칼날 축 붓싱 조절 너트	1	
B-4-7	01-017A-7600		Knife Shaft Lead Pipe	칼날 축 리이드 파이프	1	
B-4-8	01-018A-7600		Knife Shaft Worm Wheel	칼날 축 웜 휠	1	
B-11	01-029A-7600		Knife Shaft Lead Pipe Key	칼날 축 리이드 파이프 키	1	
B-13	01-023A-7600		Knife Shaft Worm	칼날 축 웜	1	
B-14	01-024A-7600		Knife Adjusting Knob	칼날 조절 손잡이	1	
B-15	05-022C-3400		Knife Adjusting Knob Taper Pin	칼날 조절 손잡이 핀	1	
B-16	01-026A-7600		Knife Adjusting Handle	칼날 조절 핸들	1	
B-17	01-028C-7600		Knife Adjusting Handle Knob	칼날 조절 핸들 손잡이	1	
B-18	01-027P-7600		Knife Adjusting Handle Knob Pin	칼날 조절 핸들 손잡이 핀	1	
B-19	01-019A-7600		Pulley Shaft Flange Holder	후렌치 홀더	1	
B-20	SC-0112-2302		Screw(9/32" n=28)	링크 캠 쥘나사A(9/32" n=28)	1	
B-21	SC-0362-7600		Screw(9/32" n=28)	후렌치 홀더 고정나사B(9/32" n=28)	1	
B-22	01-031R-7600		Rubber Bushing	후렌치 홀더 고무 붓싱	2	
B-23	01-043A-7600		Flange Shaft	후렌치 축	2	
B-24	SC-0110-1230		Screw(15/64" n=28)	후렌치 홀더 고무 붓싱 쥘나사(15/64" n=28)	2	
B-25	01-042A-7600		Pulley Shaft Flange	풀리 축 후렌지	1	
B-26	SC-0112-2302		Screw(9/32" n=28)	링크 캠 쥘나사A(9/32" n=28)	1	
B-27	SC-0362-7600		Screw(9/32" n=28)	후렌치 홀더 고정나사B(9/32" n=28)	1	
B-28	01-039A-7600		Pulley Shaft	풀리 축	1	
B-29	01-060C-7600		Pulley Shaft Key(Small)	풀리 축 키(소) 3×10	1	
B-30	01-059C-7600		Pulley Shaft Key(Large)	풀리 축 키(대) 3×16	1	
B-31	01-034A-7600		Pulley Shaft Flange Nut	풀리 축 후렌지 너트	1	
B-32	01-057S-7600		Hexagonal Nut(A)	풀리 고정 너트	1	
B-33	01-012A-7600		Pulley Shaft Bearing	베어링(6203 Z)	2	
B-34	01-040A-7600		Pulley Shaft Metal	풀리 축 붓싱	1	
B-35	SC-0362-7600		Screw(9/32" n=28)	풀리 축 붓싱 고정 볼트(5/16" n=24)	4	
B-36	01-058A-7600		Clutch Bushing	클러치 붓싱	1	
B-37	GP-016179-00		Clutch	클러치	1	
B-38	01-038A-7600		Pulley	풀리	1	
B-39	01-062A-7600		Clutch Slide Block	클러치 블럭	1	
B-40	01-052A-7600		Clutch Slide Block Screw	클러치 블럭 축	1	
B-41	01-053A-7600		Clutch Lever	클러치 레버	1	
B-42	01-054A-7600		Clutch Lever Shaft	클러치 레버 축	1	
B-43	05-022C-3400		Pin For B-42	칼날 조절 핸들 손잡이 핀	1	
B-44	01-050A-7600		Holder For Clutch Lever Shaft	클러치 레버 축 홀더	1	
B-45	SC-0162-5607		Screw(M5×0.8)	사절 레버 쥘나사(M5×0.8)	2	
B-46	01-055A-7600		Clutch Arm	클러치 레버 축 손잡이	1	
B-47	01-182P-7600		Pin (3×16)	클러치 레버 축 손잡이 핀	1	
B-48	01-047G-7600		Clutch Lever Spring	클러치 레버 스프링	1	
B-49	SC-0194-2302		Screw(3/16" n=28)	들레 크랭크 쥘나사(3/16" n=28)	1	



Grindstone & Roller Related Parts

저석 및 로올러 관계

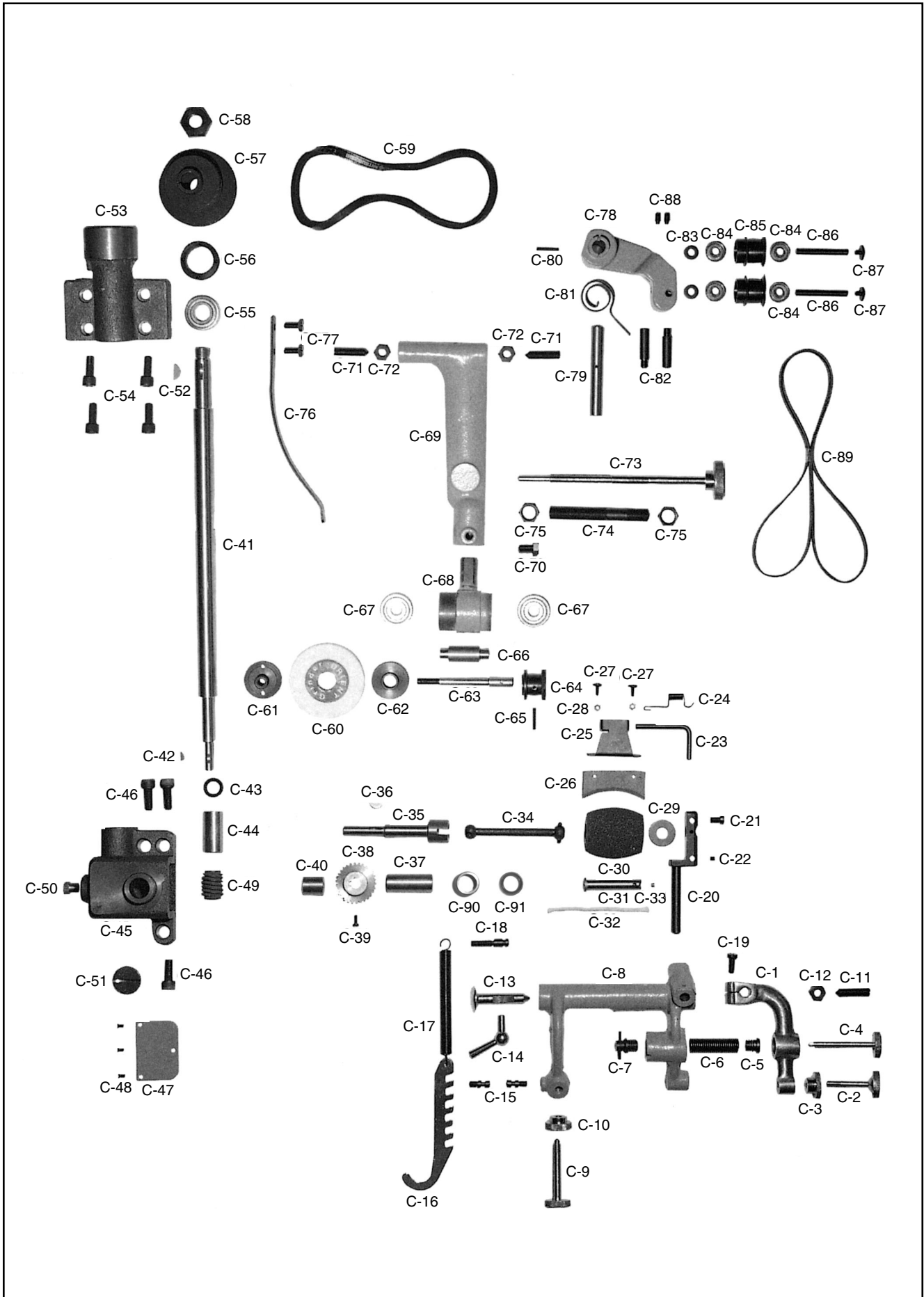



Ref. No.	Parts No.	Note	Name of Parts	품 명	Q' ty	Assembly No.
C-1	01-299A-7600		Roller Bracket Turning Arm	로올러 브라켓 회전암	1	
C-2	01-101S-7600		Roller Bracket Turning Arm Adjusting Screw	로올러 브라켓 회전암 조절나사	1	
C-3	01-102C-7600		Roller Bracket Turning Arm Adjusting Screw Nut	로올러 브라켓 회전암 조절나사 너트	1	
C-4	01-106S-7600		Roller Bracket Turning Arm Spring Adjusting Screw	로올러 회전암 스프링 조절나사	1	
C-5	01-107C-7600		Roller Bracket Turning Arm Spring Adjusting Screw Nut	로올러 암 스프링 조절나사 너트	1	
C-6	01-103G-7600		Roller Bracket Turning Arm Spring	로올러 브라켓 회전암 스프링	1	
C-7	01-104A-7600		Roller Bracket Turning Arm Spring Stopper	로올러 브라켓 회전암 스톱퍼	1	
C-8	01-308A-7600		Roller Bracket Arm	로올러 브라켓 서포트 암	1	
C-9	01-111S-7600		Roller Bracket Arm Adjusting Screw	서포트 암 조절나사	1	
C-10	01-112C-7600		Roller Bracket Arm Adjusting Screw Nut	서포트 암 조절나사 너트	1	
C-11	SC-0357-7600		Screw(5/16" n=24)	저석축 브라켓 암 지지나사(5/16" n=24)	1	
C-12	SN-0110-7600		Nut(5/16" n=24)	저석축 브라켓 암 지지나사 너트(5/16" n=24)	1	
C-13	01-117P-7600		Roller Bracket Arm Center Pin	서포트 암 지지핀	1	
C-14	01-118S-7600		Roller Bracket Arm Center Pin Screw	서포트 암 지지핀 고정나사	1	
C-15	01-115C-7600		Roller Bracket Arm Spring Hook(1)	서포트 암 스프링 걸이(소)	2	
C-16	01-114C-7600		Roller Bracket Arm Spring Hook Metal	서포트 암 스프링 걸이 판	1	
C-17	01-113G-7600		Roller Bracket Arm Spring	서포트 암 스프링	1	
C-18	01-116C-7600		Roller Bracket Arm Spring Hook(2)	서포트 암 스프링 걸이(대)	1	
C-19	SC-0183-2700		Screw(15/64" n=28)	로올러 브라켓 회전 암 쥘나사(15/64" n=28)	1	
C-20	01-097A-7600		Roller Bracket	로올러 브라켓	1	
C-21	SC-0540-7600		Screw(15/64" n=28)	로올러 브라켓 쥘나사(15/64" n=28)	1	
C-22	SC-0512-1230		Screw(11/64" n=40)	하측 카라 나사(11/64" n=40)	1	
C-23	01-121C-7600		Waste Clear Metal Shaft	천조각 제거판 축	1	
C-24	01-123G-7600		Waste Clear Metal Spring	천조각 제거판 스프링	1	
C-25	01-120C-7600		Waste Clear Metal	천조각 제거판	1	
C-26	01-124R-7600		Waste Clear Metal Leather	천조각 제거판 패드	1	
C-27	SC-0541-7600		Screw(9/64" n=40)	천조각 제거판 패드 쥘나사(9/64" n=40)	2	
C-28	01-126S-7600		Waste Clear Metal Leather Nut	천조각 제거판 패드 쥘 나사 너트	2	
C-29	43-003W-5607		Roller Washer	무릎올림 레버와셔	1	
C-30	01-093A-7600		Roller	로올러(조)	1	
C-31	01-094A-7600		Roller Shaft	로올러 축	1	
C-32	44-032M-1230		Roller Shaft Oil Wick	오일 심지	1	
C-33	07-003C-3400		Roller Shaft Oil Seal Plug	하측 앞 붓싱 기름구멍 마개(대)	1	
C-34	01-146A-7600		Roller Driving Shaft Joint	로올러 구동축 조인트	1	
C-35	01-243A-7600		Roller Driving Shaft	로올러 구동축	1	
C-36	01-022C-7600		Knife Shaft Key	칼날축 키(3×13)	1	
C-37	01-344A-7600		Roller Driving Shaft Metal(1)	로올러 구동축 앞 붓싱	1	
C-38	01-140A-7600		Main Shaft Worm Gear Wheel	주축 웜 휠	1	
C-39	SC-0156-7500		Screw(9/64" n=40)	홈볼이 냄비 작은나사(9/64" n=40)	1	
C-40	01-245A-7600		Roller Driving Shaft Metal(2)	로올러 구동축 뒷 붓싱	1	
C-41	01-130A-7600		Main Shaft	주축	1	
C-42	01-152C-7600		Main Shaft Key(1)	주축 키(소) (2.5×10)	1	
C-43	01-156A-7600		Main Shaft Worm Gear Chamber Oil Seal	주축 웜기어 박스 오일셀	1	
C-44	01-142A-7600		Main Shaft Front Bushing	주축 앞 붓싱	1	
C-45	01-136A-7600		Main Shaft Worm Gear Box	주축 웜기어 박스	1	
C-46	SC-0325-3800		Screw (M8×1.25)	베드 힌지 쥘나사 (M8×1.25)	3	
C-47	01-148C-7600		Worm Chamber Plate	주축 웜기어 박스 뚜껑	1	
C-48	SC-A301-4119		Screw (9/64" n=40)	홈볼이 둥근 접시 작은나사(9/64" n=40)	3	
C-49	01-139A-7600		Main Shaft Worm Gear	주축 웜기어	1	
C-50	01-151C-7600		Main Shaft Worm Gear Chamber Screw	주축 웜기어 배유 볼트	1	
C-51	01-150S-7600		Main Shaft Worm Gear Chamber Cover Screw	주축 웜기어 마개나사	1	



Grindstone & Roller Related Parts

저석 및 로올러 관계

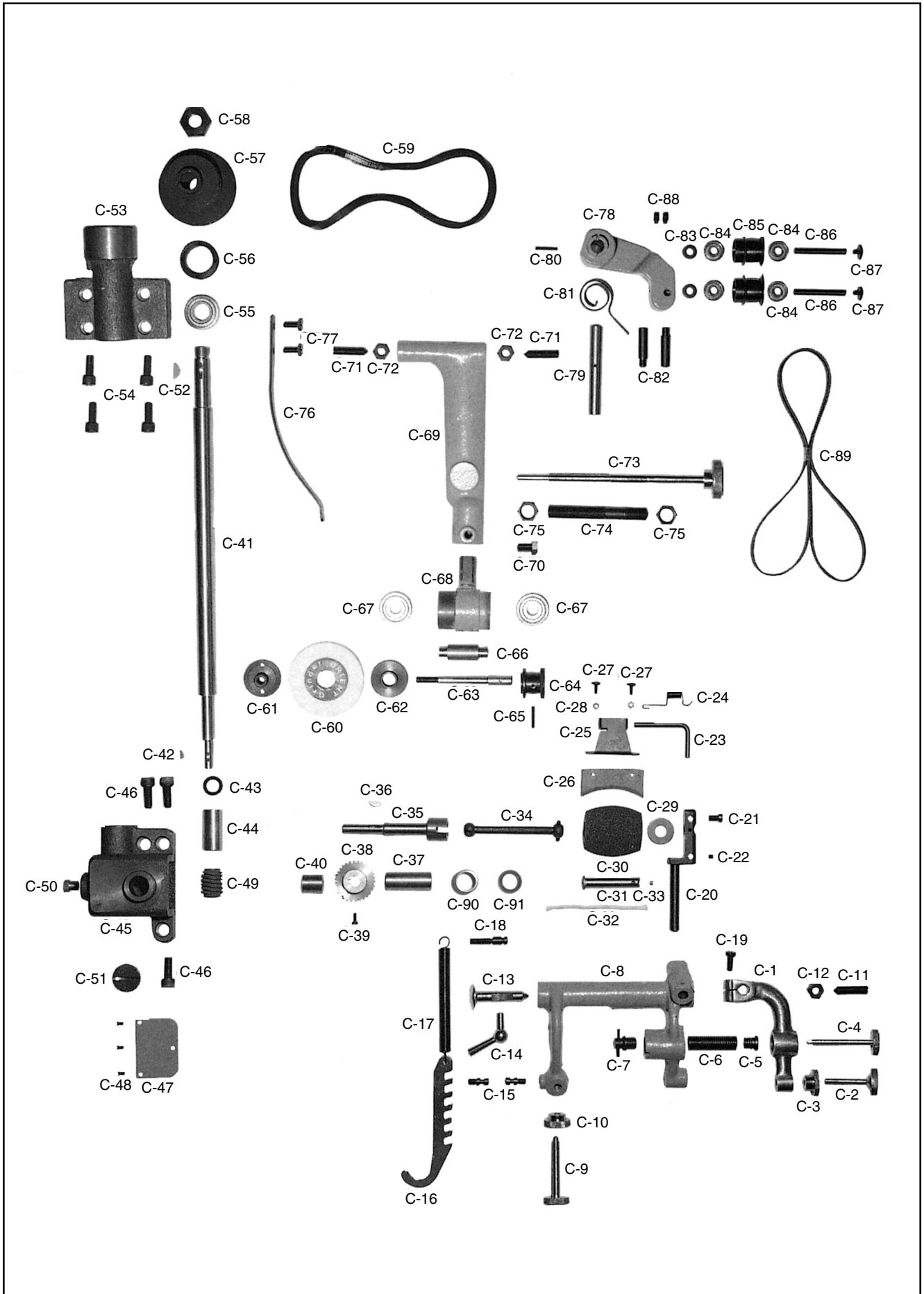

Ref. No.	Parts No.	Note	Name of Parts	품 명	Q' ty	Assembly No.
C-52	01-059C-7600		Main Shaft Key(2)	폴리축 키 (대) 3×16	1	
C-53	01-132A-7600		Main Shaft Rear Bushing	주축 뒷 붓싱	1	
C-54	SC-0325-3800		Screw (M8×1.25)	베드 힌지 쥘나사(M8×1.25)	4	
C-55	01-155A-7600		Main Shaft Bearing	주축 베어링	1	
C-56	01-135S-7600		Main Shaft Bearing Holder Screw	주축 베어링 잠금나사	1	
C-57	01-131A-7600		Main Shaft Pulley	주축 폴리	1	
C-58	01-154C-7600		Hexagonal Nut (B)	주축 폴리 고정너트	1	
C-59	01-153A-7600		Main Shaft Belt	주축 벨트(MISBOSHI K20)	1	
C-60	01-163A-7600		Grindstone	저석	1	
C-61	01-165S-7600		Grindstone Set Screw	저석 고정 나사 너트	1	
C-62	01-164A-7600		Grindstone Set Screw Nut	저석 고정 너트	1	
C-63	01-066A-7600		Grindstone Shaft	저석 축	1	
C-64	01-167A-7600		Grindstone Shaft Pulley	저석 축 폴리	1	
C-65	05-022C-3400		Grindstone Shaft Pulley Taper Pin	누름대 올리기 스톱퍼(3×20)	1	
C-66	01-069A-7600		Grindstone Shaft Bearing Holding Roller	저석 축 베어링 홀더	1	
C-67	01-088A-7600		Grindstone Shaft Bearing	저석 축 베어링	2	
C-68	01-070A-7600		Grindstone Shaft Bracket	저석 축 브라켓	1	
C-69	01-072A-7600		Grindstone Shaft Bracket Arm	저석 축 브라켓 암	1	
C-70	SC-0209-7600		Screw (5/16" n=24)	저석 축 브라켓 쥘나사 (5/16" n=24)	1	
C-71	SC-0357-7600		Screw (5/16" n=24)	저석 축 브라켓 암 지지나사 (5/16" n=24)	2	
C-72	SN-0110-7600		Nut (5/16" n=24)	저석 축 브라켓 암 지지나사 너트(5/16" n=24)	2	
C-73	01-073S-7600		Grindstone Adjusting Screw	저석 조절 나사	1	
C-74	01-084A-7600		Grindstone Adjusting Screw Pipe	저석 조절나사 파이프	1	
C-75	SN-0106-7600		Nut (1/2" n=28)	저석 조절나사 파이프 너트 (1/2" n=28)	2	
C-76	01-086G-7600		Grindstone Shaft Bracket Arm Spring	저석축 브라켓 암 스프링	1	
C-77	SC-0106-7400		Screw (15/64" n=28)	포크 쥘나사 (15/64" n=28)	2	
C-78	01-075A-7600		Belt Guide Bracket	벨트 안내 브라켓	1	
C-79	01-077A-7600		Belt Guide Bracket Shaft	벨트 안내 브라켓 축	1	
C-80	05-022C-3400		Belt Guide Bracket Taper Pin	누름대 올리기 스톱퍼(3×20)	1	
C-81	01-085G-7600		Belt Guide Bracket Spring	벨트 안내 브라켓 스프링	1	
C-82	01-083A-7600		Belt Guide Bracket Turning Stopper	벨트 안내 스톱퍼	2	
C-83	01-082W-7600		Belt Guide Pulley Washer	벨트 안내 폴리 와셔	2	
C-84	01-089A-7600		Belt Guide Pulley Bearing	벨트 안내 폴리 베어링	4	
C-85	01-178A-7600		Belt Guide Pulley	벨트 안내 폴리	2	
C-86	01-079A-7600		Belt Guide Pulley Shaft	벨트 안내 폴리 축	2	
C-87	SC-0316-2350		Screw (11/64" n=40)	스프링 걸이 위치 고정나사 (11/64" n=40)	2	
C-88	01-080S-7600		Screw (15/64" n=28)	홈볼이 멈춤나사(15/64" n=28)	2	
C-89	01-074A-7600		Grindstone Shaft Belt	저석 축 벨트 (7×960mm)	1	
C-90	16069BR-7600		Needle Roller Bearing	니들 롤러 베어링	1	
C-91	01-244A-7600		Oil Seal	오일 씬	1	

D

Accessories 액세서리

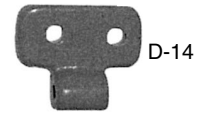
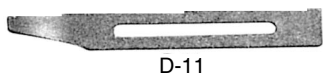
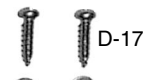
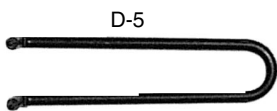
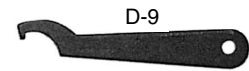
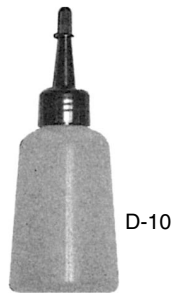
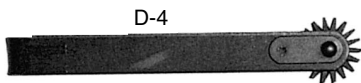
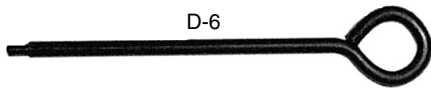
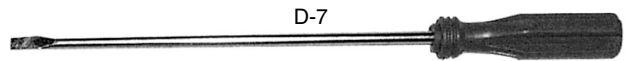

Ref. No.	Parts No.	Note	Name of Parts	품 명	Q' ty	Assembly No.
D-1	91-004A-7600		Presser Foot(40mm)	노루발 B(대)	1	
D-2	91-005A-7600		Presser Foot(30mm)	노루발 C(중)	1	
D-3	91-006A-7600		Presser Foot(25mm)	노루발 D(소)	1	
D-4	91-011A-7600		Grindstone Dresser	저석 축 드레서	1	
D-5	91-012C-7600		Grindstone Nut Spanner	저석 고정너트 스패너	1	
D-6	91-014C-7600		Knife Inner Cover Remover	칼날 내면 커버 분해축	1	
D-7	91-102C-1230		Driver(Large)	드라이버(대)	1	
D-8	91-015A-7600		Bar Type Grindstone	저석 봉	1	
D-9	91-013C-7600		Knife Shaft Spanner	칼날 축 너트 스패너	2	
D-10	91-011C-1230		Oiler	유차	1	
D-11	91-001A-7600		Ruler	전방 정규	1	
D-12	91-002W-7600		Ruler Set Screw Washer	정규 쥘나사 와셔	1	
D-13	91-003S-7600		Ruler Set Screw	정규 쥘나사	1	
D-14	91-007A-7600		Hinges	힌지	2	
D-15	GP-012154-00		Hinge Pins	힌지 축	2	
D-16	91-009W-7600		Hinge Set Screw Washer	힌지 쥘나사 와셔	4	
D-17	91-003S-2302		Hinge Set Screw	힌지 쥘나사	4	

수정 리스트

Changed Parts List

No.	Ref. No.	Parts No.	Name of Parts	Contents	Date	Old Parts No.	Remarks
1	B-47	01-182P-7600	Spring Pin(3×16)	Substitution	98. 4	05-022C-3400	98. 3/4
2	D-17	91-003S-2302	Screw	Substitution	98. 4	91-008S-7600	
3	A-4	01-007S-7600	Screw(11/64" n = 40)	Substitution	98. 9	SC-0119-4119	98. 4/4
4	A-15	SC-0175-4522	Screw(11/64" n = 40)	Substitution	98. 10	SC-0543-4525	
5	B-43	05-022C-3400	Pin For B-42	Substitution	98. 10	01-027P-7600	
6	C-39	SC-0156-4118	Screw(9/64" n = 40)	Substitution	98. 3	SC-A156-4118	99. 1/4
7	C-88	01-080S-7600	Screw(15/64" n = 28)	Substitution	98. 3	SC-0146-4315	
8	A-6	01-007S-7600	Screw(11/64" n = 40)	Substitution	99. 12	SC-0119-4119	99. 4/4
9	A-8	01-007S-7600	Screw(11/64" n = 40)	Substitution	99. 12	SC-0119-4119	
10	C-61	01-065S-7600	Grindstone Set Screw	Substitution	01. 03	01-064A-7600	01. 1/4
11	C-62	01-064A-7600	Grindstone Set Screw Nut	Substitution	01. 03	01-065S-7600	01. 1/4
12	C-37	01-344A-7600	Roller Driving Shaft Metal(1)	Change for Blue Point	01. 09	01-144A-7600	01. 3/4
13	C-40	01-245A-7600	Roller Driving Shaft Metal(2)	Change for Blue Point	01. 09	01-245A-7600	01. 3/4
14	A-4	01-007S-7600	Screw(11/64" n = 40)	Substitution	01. 09	01-007S-7600	01. 3/4
15	A-6	01-007S-7600	Screw(11/64" n = 40)	Substitution	01. 09	01-007S-7600	01. 3/4
16	A-8	01-007S-7600	Screw(11/64" n = 40)	Substitution	01. 09	01-007S-7600	01. 3/4
17	A-15	SC-0543-2302	Screw(11/64" n = 40)	Substitution	01. 09	SC-0175-4522	01. 3/4
18	A-18	SC-0333-7600	Screw(15/64" n = 28)	Substitution	01. 09	SC-0333-4123	01. 3/4
19	A-28	SC-0220-7600	Screw(3/16" n = 28)	Substitution	01. 09	SC-0220-2122	01. 3/4
20	A-31	SC-0527-7600	Screw(3/16" n = 28)	Substitution	01. 09	SC-0527-4123	01. 3/4
21	A-32	SC-0359-7600	Screw(9/64" n = 40)	Substitution	01. 09	SC-0359-4115	01. 3/4
22	A-35	SC-0345-7600	Screw(15/64" n = 28)	Substitution	01. 09	SC-0345-4318	01. 3/4
23	A-39	SC-0319-7600	Screw(1/2" n = 28)	Substitution	01. 09	SC-0319-4122	01. 3/4
24	A-45	SC-0526-7600	Screw(3/16" n = 28)	Substitution	01. 09	SC-0526-4122	01. 3/4
25	B-3	SC-0197-7600	Screw(M6×1.0)	Substitution	01. 09	SC-0197-4122	01. 3/4
26	B-20	SC-0112-2302	Screw(9/32" n = 28)	Substitution	01. 09	SC-0112-4315	01. 3/4
27	B-21	SC-0362-7600	Screw(9/32" n = 28)	Substitution	01. 09	SC-0362-4515	01. 3/4
28	B-24	SC-0110-1230	Screw(15/64" n = 28)	Substitution	01. 09	SC-0110-4115	01. 3/4
29	B-26	SC-0112-2302	Screw(3/32" n = 28)	Substitution	01. 09	SC-0112-4315	01. 3/4
30	B-27	SC-0362-7600	Screw(9/32" n = 28)	Substitution	01. 09	SC-0362-4515	01. 3/4
31	B-35	SC-0342-7600	Screw(5/16" n = 24)	Substitution	01. 09	SC-0342-4111	01. 3/4
32	B-45	SC-0162-5607	Screw(M5×0.8)	Substitution	01. 09	SC-0162-4113	01. 3/4
33	B-49	SC-0194-2302	Screw(3/16" n = 28)	Substitution	01. 09	SC-0194-4118	01. 3/4
34	C-11	SC-0357-7600	Screw(5/16" n = 24)	Substitution	01. 09	SC-0357-4415	01. 3/4
35	C-12	SN-0110-7600	Screw(5/16" n = 24)	Substitution	01. 09	SN-0110-4000	01. 3/4
36	C-19	SC-0183-2700	Screw(15/64" n = 28)	Substitution	01. 09	SC-0183-4122	01. 3/4
37	C-21	SC-0540-7600	Screw(15/64" n = 28)	Substitution	01. 09	SC-0540-4125	01. 3/4
38	C-22	SC-0512-1230	Screw(11/64" n = 40)	Substitution	01. 09	SC-0512-4515	01. 3/4
39	C-27	SC-0541-7600	Screw(9/64" n = 40)	Substitution	01. 09	SC-0541-4125	01. 3/4
40	C-46	SC-0325-3800	Screw(M8×1.25)	Substitution	01. 09	SC-0325-4113	01. 3/4

NOTE)

수정 리스트

Changed Parts List

No.	Ref. No.	Parts No.	Name of Parts	Contents	Date	Old Parts No.	Remarks
41	C-54	SC-0325-3800	Screw(M8×1.25)	Substitution	01. 03	SC-0325-4113	01. 3/4
42	C-70	SC-0209-7600	Screw(5/16" n=24)	Substitution	01. 09	SC-0209-4113	01. 3/4
43	C-71	SC-0357-7600	Screw(5/16" n=24)	Substitution	01. 09	SC-0357-4415	01. 3/4
44	C-72	SN-0110-7600	Screw(5/16" n=24)	Substitution	01. 09	SN-0110-4000	01. 3/4
45	C-75	SN-0106-7600	Nut(1/2" n=28)	Substitution	01. 09	SN-0106-4000	01. 3/4
46	C-77	SC-0106-7400	Screw(15/64" n=28)	Substitution	01. 09	SC-0106-4111	01. 3/4
47	C-87	SC-0316-2350	Screw(11/64" n=40)	Substitution	01. 09	SC-0316-4124	01. 3/4
48	C-64	01-167A-7600	Grindstone Shaft Puley	Substitution	03. 02	01-067A-7600	03. 1/4
49	C-85	01-178A-7600	Belt Guide Pulleys	Substitution	03. 02	01-078A-7600	03. 1/4
50	C-39	SC-0156-7500	Screw	Substitution	03. 06	SC-A156-4118	03. 2/4
51	B-45	SC-0162-5607	Screw	Substitution	03. 06	SC-0162-5607	03. 2/4
52	C-85	01-308A-7600	Roller Bracket Arm	Substitution	03. 06	01-108A-7600	03. 2/4
53	A-40	01-375A-7600	Presser Bar Lifter Lever	Substitution	03. 06	01-175A-7600	03. 2/4
54	A-41	01-376A-7600	Presser Bar Lifter Bracket	Substitution	03. 06	01-176A-7600	03. 2/4
55	D-7	91-102C-1230	Driver (L)	Substitution	03. 06	91-002C-1230	03. 2/4
56	C-60	01-163A-7600	Grindstone	Substitution	03. 08	01-063A-7600	03. 3/4
57	C-1	01-299A-7600	Roller Bracket Turning Arm	Substitution	03. 08	01-099A-7600	03. 3/4
58	A-40	01-375A-7600	Presser Bar Lifter Lever	Substitution	04. 01	01-175A-7600	04. 1/27
59	A-41	01-376A-7600	Presser Bar Lifter Bracket	Substitution	04. 01	01-176A-7600	04. 1/27
60	C-1	01-299A-7600	Roller Bracket Turning Arm	Substitution	04. 01	01-099A-7600	04. 1/27
61	C-8	01-308A-7600	Roller Bracket Arm	Substitution	04. 01	01-108A-7600	04. 1/27
62	C-39	SC-0156-7500	Screw(9/64" n=40)	Substitution	04. 01	SC-0156-4118	04. 1/27
63	C-60	01-163A-7600	Grindstone	Substitution	04. 01	01-063A-7600	04. 1/27
64	C-64	01-167A-7600	Grindstone Shaft Puley	Substitution	04. 01	01-067A-7600	04. 1/27
65	C-85	01-178A-7600	Belt Guide Pulley	Substitution	04. 01	01-078A-7600	04. 1/27
66	D-7	91-102C-1230	Driver (Large)	Substitution	04. 01	91-002C-1230	04. 1/27
67				Substitution	04. 01		04. 1/27
68				Substitution	04. 01		04. 1/27
69				Substitution	04. 01		04. 1/27
70				Substitution	04. 01		04. 1/27
71							
72							
73							
74							
75							
76							
77							
78							
79							
80							

NOTE)